

Review

# Regulatory Paradigm and Challenge for Blockchain Integration of Decentralized Systems: Example—Renewable Energy Grids

Ernest Barceló <sup>1,2</sup>, Katarina Dimić-Mišić <sup>1</sup>, Monir Imani <sup>1</sup>, Vesna Spasojević Brkić <sup>3,\*</sup>, Michael Hummel <sup>1</sup> and Patrick Gane <sup>1,4</sup>

<sup>1</sup> Department of Bioproducts and Biosystems, School of Chemical Engineering, Aalto University, 00076 Helsinki, Finland

<sup>2</sup> Group Sustainability, Omya International AG, 4665 Oftringen, Switzerland

<sup>3</sup> Faculty of Mechanical Engineering, University of Belgrade, 11000 Belgrade, Serbia

<sup>4</sup> Faculty of Technology and Metallurgy, University of Belgrade, 11200 Belgrade, Serbia

\* Correspondence: vspasojevic@mas.bg.ac.rs

**Abstract:** Nowadays, fossil fuels are used in a clearly unsustainable way that can bring potentially catastrophic consequences. Electricity is currently delivered to end users by generation and energy transmission companies. Previous research shows that the development of modern circular economy sets a need for the re-orientation of socio and economic development of decentralized systems, including energy basis. In addition to being ecological, the use of renewable energy sources also has economic significance by contributing to energy independence. Citizens, industries, local and national authorities become interconnected within emerging novel renewable energy sourcing communities, through which they establish trade of energy and, most importantly, models of investing and reshaping the distribution of renewable energy. The modern portfolio management of renewable energy networking is aiming toward decentralized systems of trade, where the consumer becomes a producer (prosumer) within the network, itself managed by users. Excess energy produced in the micro-grid nets within the over-arching national and transnational energy grid should be accounted for and managed with blockchain technology for financial and structural security. The decentralization of the energy market requires the establishment of strict norms that will regulate the market and taxation of profits arising. The extensive literature review on blockchain in the energy sector reflects a very pragmatic and narrow approach to the topic, although it is evident that the distribution of energy within the blockchain would enable economic development through reducing cost and ensuring more secure energy trade. Blockchain technology embeds the related digital codes, in which information will be visible to all, but also secured from hacking and duplicating. However, there are challenges to this paradigm, not least the energy consumption of the extensive nodal mesh required to perform the necessary protocols. This paper aims to provide an overview of the application of blockchain technology and the need for the development of the regulatory system and of potential solutions to the challenges posed. By undertaking an energy consumption analysis of blockchain implementation from first electronic principles, which has not been constructed before in the literature, this paper's conclusion stresses the future demand for reducing energy consumption and considers the latest findings in the quantum coupling of light signals as a potential for solving the enormous ledger duplication structure problem.

**Keywords:** renewable energy; blockchain; energy tokens; virtual power plants; decentralized renewables

**Citation:** Barceló, E.; Dimić-Mišić, K.; Imani, M.; Spasojević Brkić, V.; Hummel, M.; Gane, P. Regulatory Paradigm and Challenge for Blockchain Integration of Decentralized Systems: Example—Renewable Energy Grids. *Sustainability* **2023**, *15*, 2571. <https://doi.org/10.3390/su15032571>

Academic Editors: Marek Jasinski, Zbigniew Leonowicz, Michał Jasiński and Elżbieta Jasińska

Received: 26 December 2022

Revised: 11 January 2023

Accepted: 19 January 2023

Published: 31 January 2023



**Copyright:** © 2023 by the authors. Licensee MDPI, Basel, Switzerland. This article is an open access article distributed under the terms and conditions of the Creative Commons Attribution (CC BY) license (<https://creativecommons.org/licenses/by/4.0/>).

## 1. Introduction

The dizzying evolution of the Internet has transformed how our society accesses data and communicates, simultaneously increasing data and storage capacities. Despite these advantages of instantaneous sharing widely, there exists the danger that data can be lost,

corrupted, censored, or accidentally deleted [1]. Blockchain is a method that dates from 2008, used initially to verify cryptocurrency transactions via a series of digital signals that transmit blocks of time-stamped, append-only groupings with ordered data, which can be the property of a single entity, and so eliminate otherwise random data transmission problems [1,2]. Improved data integrity brings new possibilities in trade-moving (transactions) which, following information theory principles, is real-world staggering [2]. By reviewing a blockchain history of any transaction, it is possible to know with certainty that the related inventory has occurred in a particular place and at a given time [3]. The technique of verifying in this way brings with it declining cost and uncertainty, while a stamped transaction record cannot be manipulated, thus decreasing the possibility of fraud [4]. Within a wide span of industries and functions, blockchain can reduce bureaucracy, re-focusing capacity towards the creation of entirely new business models [1,4]. Historically, technological innovations have been the main driver of social development, and at the moment blockchain is contributing to continued development as an example of a technological revolution of modern time [5].

Even though decades may pass before the ramification of new technologies can be evaluated, their applications always bring huge changes in society. Even though blockchain seems to be complicated technology, on the one hand, underestimating its impact can be decisive in determining the length of time to reach its pivotal moment. Since blockchain is changing and displacing established technologies, it is simultaneously creating new socio-economical models with effect in years to come, transforming business and government [6]. Therefore, on the other hand, rushing into blockchain innovations could lead to long term misjudgment without cultivating a sufficiently deep understanding of its usage and application. It is, therefore, important to have a consolidated view on the advantages, and to recognize and seek solutions to the resulting challenges arising from this technology, as this paper aims to do. The structure of this paper is as follows. After presenting the background to blockchain development, literature research methodology is given, after that, the review of current status is described. The review of current status is focused on patterns of energy sector development, centralized and decentralized blockchain networks for consumption, consensus algorithms in blockchain technology, federated byzantine agreement, application to decentralized energy and micro-generation, regulatory development for blockchain renewable energy grid, and further expansion opportunities and potential roadblocks for blockchain. The last section contains conclusions.

### *Background to Blockchain Development*

Blockchain is drawing much public and business attention and, therefore, is of interest to governments and their policies. Various industries are interested to modernize their trade supply chain and they are investing into efforts to investigate potential of this technology in respect to cutting costs in trade, making them more sustainable and reducing time consuming traditionally documented trade, which is presently required at each stage of the process [3,7]. The possibility of interconnecting trade carriers, such as producers, banks, logistic chains, exporters, importers, sellers, and consumers, into one single transnational trade supply chain is extremely attractive, as it offers compliance with the control of the trade chain [8]. Furthermore, the use of blockchain technology enables the sustainable management of provenance and transparency of documentation, whilst eliminating monopoly, forgery, and unnecessary risks in trade [1,8].

The most relevant transformational process that has been typical of other foundational technologies is the model of networking computers, which has enabled transmission control protocol/internet protocol (TCP/IP), already established in 1972 within a single-use case in a basis for email security searchers in APPANET, which was a precursor of the systems introduced by the US Department of Defense [9]. Prior to TCP/IP, the architecture of telecommunications was built on “circuit switching”, through pre-established connections between two parties via an exchange enabled by building billions of dedicated lines. The new model in TCP/IP started to transform information flow by slowly

digitizing and breaking the standard model down into small packets together with their addresses and information, with which they were released into the network [9,10]. Later, in the late 1980s and beginning of the 1990s, more companies started to use this technology in establishing private networks within large organizations, by developing TCP/IP technology and introducing new tools and broadening its use outside the scope of emails, which simultaneously led to the replacement of traditional network technologies [10]. In the mid-1990s, the World Wide Web was introduced, and TCP/IP entered broad public use, together with the provision of hardware, software, and other “plumbing” services that were necessary to connect emerging public networks for information exchange by taking advantage of low cost connectivity [11]. Modern internet services were created that were substitutes for many existing businesses, such as CNET then introducing news online, Priceline, and Expedia putting airplane ticket sales online, all leading to increasing pressure on traditional business [12]. With broader internet connectivity, many companies started to use peer to peer architecture by coordinating transmission of their product between networks and users. Companies such as ebay changed retail business in this way, while Skype changed telecommunication, and Google the task of web searching [13]. It took over 30 years since TCP/IP was introduced before society and economy were reshaped, bringing ease and readiness to economic transactions, access to intellectual property, and further democratizing societies [14]. Thus, similarly as TCP/IP brought new economic values, drastically decreasing connection costs, blockchain, following within this context, exhibits the possibility to become the system that will eventually keep record of all such transactions [9,14].

Nowadays, many organizations still keep record of all transactions as private property without maintaining a master ledger of their activities. Time consuming transactions between the organization (private ledger) and individuals who purchase product and services are prone to errors [15]. When, in October 2008, a blockchain status was introduced that was an online and virtual system of currency transaction, a technology was established that provided immediate transaction confirmation and ownership transfer without passing through a central authority [16]. With the use of blockchain technology, stock transactions can be executed within microseconds through the ledger, which is instantaneously replicated via a vast number of identical databases with use of computers only [1,9]. Exploring this potential further has drawn increasing attention of business and researchers alike.

## 2. Literature Research Methodology

A literature review is adopted here as a research methodology in order to locate existing relevant peer-reviewed studies based on blockchain technology research, with the aim to shed light on the development of blockchain in modern technological supply chains. Furthermore, the methodology enables the discussion of the role of blockchain in overcoming challenges in the present trade industry towards meeting the demands of a decentralized trade network between multiple partners and possible related scenarios. Finally, the review leads to outlining the necessity of defining standards of technology application and regulation at governmental level to enable the sustainable application of blockchain and provide uniform standards on the global scale, not only in respect to trade protocols, but including the establishment of research to find solutions to the challenges blockchain brings, both societal and, not least, the allied control of the blockchain network energy consumption.

In the search for literature, we applied the terms: “Blockchain”, “Sustainable development in energy sector”, “Blockchain as in sustainable energy”, “Trends in sustainable energy” and keywords, “Blockchain”, “Sustainable energies”, “Renewables”, “Blockchain in trade”.

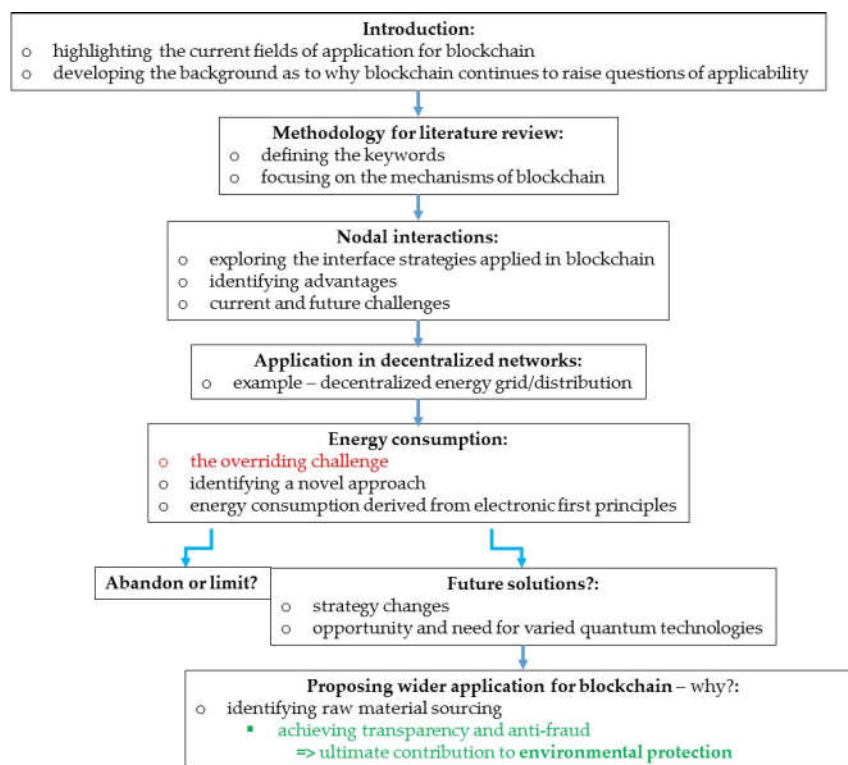
To identify publications, having accorded defined search keywords, we opted for a broad literature search using the search engine Google Scholar. Given the critical viewpoint of this article, however, we restricted the literature search to regulatory bodies and

highly ranked journal articles, which enabled a reliable knowledge base to be constructed. Generic search terms, such as “blockchain supply chain” or “blockchain logistics”, were frequently applied. Overall, we searched publications in relation to the history of blockchain, technical aspects of blockchain networks and security, the application of blockchain in banking and trade, sustainability aspects of mining of blocks in cryptocurrency, and necessity for new regulations.

In our search we conducted 55 search queries, starting from June 2019 and gradually increasing our data base up to the end of 2021, which was aligned with the development of circular economy and blockchain use in various industries, and increase in renewability with the simultaneous development of blockchain technology and its application in various sectors. To increase the scope of diversability, three persons searched for publications independently, discussing their findings and viewpoints, and finally drew consensus on publications included in this research. The elimination of publications related to close similarity of topics and conclusions in relation to proven validity, such that, from 130 initially, 78 relevant publications were used as listed references.

Generally, the search methodology led to a structured literature review, including mathematical models of pilot projects. Some of the publications were themselves review articles with applications of blockchain in a specific industry, or historical background related to the development of blockchain structure, the mining of algorithms and how it became a flagship of global scale trade. We also overviewed critically the aspect of sustainability of the utilization of blockchain in the trading of energy produced from renewable sources, with reference to the large consumption of electrical energy required for the creation of blocks that will be in the chain and their mining. Together with searching for applications relevant for many industries, we also sought how they call for new regulations on a governmental level. The often discussed topics are the technical aspects of blockchain, the use of blockchain in track-and-trace, and consumers’ increase in trust for a certain product or trade type due to the use of blockchain for guarantee, anti-fraud, and transparency, which are linked to the distribution design of blockchain, and its data immutability.

To provide an overview of the review and analysis, a flowchart of the methodology is shown in Figure 1.



**Figure 1.** Methodology flowchart as overview of the review analysis construction.

### 3. Review of Current Status

#### 3.1. Patterns of Energy Sector Development

In the historical context of centralized energy as part of civil development, the individual human has never before been a functional unit of an integrated system [17,18]. Today, the material paradigm is one of the use of capabilities and resources closely related to the formation and implementation of energy as the base for socioeconomic progress [19]. Current development in sustainable energy sources has been based on the premise in which industry will use renewable materials for production within circularity in an economically prosperous way [19].

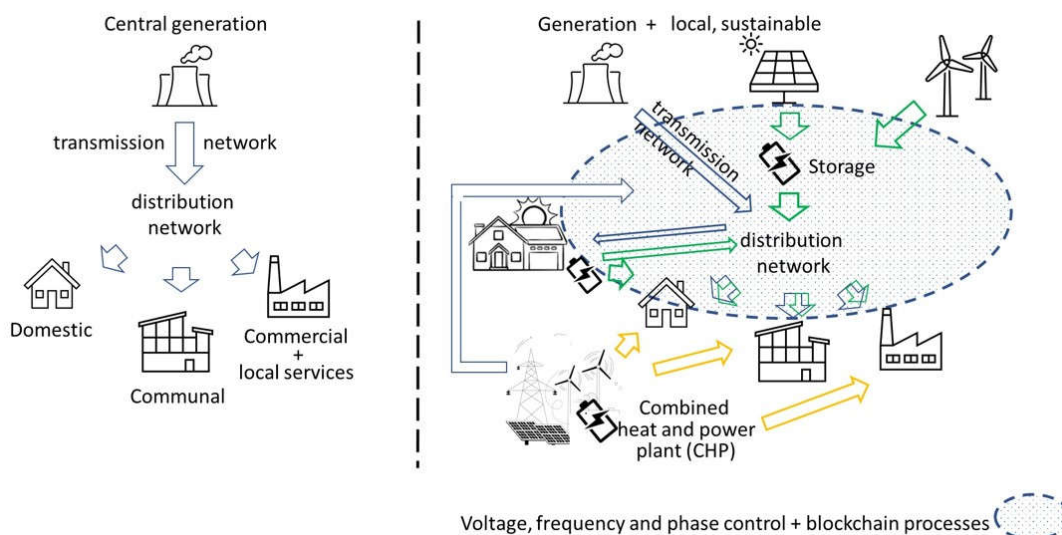
Current energy production can be divided into two categories: products related to fossil fuels used alone, i.e., forms of combustion, and electricity, generated either from the combustive use of fossil fuels or by other natural or technological means [18,19]. Renewable energy will help pave the way to a cleaner, more sustainable energy future based largely on electricity generation, with longer term emergence of green hydrogen related back to renewable energy, plus the even longer term likelihood of nuclear fusion. Within the fossil fuel category, exploration and production, refining, transportation, and retail companies produce and transport a variety of petroleum products, both liquid and gas, from the ground to the end user [18,19]. Renewables include wind power, hydropower (small and large hydroelectric power plants), solar energy (photovoltaic and solar thermal), energy extracted from the sea (waves, tides, heat, salinity, electrolysis), biomass energy and geothermal energy (huge residual amounts of unused or untapped energy) [20]. However, these resources cannot be used without the introduction of the right incentives and legal frameworks, for which the Global Climate Commission and the institutions of the European Union have been activated and are advocating [21]. As the energy market is facing challenges in operation of conventional power plants, they also have to contend with high costs in long-distance energy transmission processes [9,19,20]. The existing electricity model, with its immense infrastructure, will not be able to cope with the increasing

demand for electricity, which is expected to more than double by 2050, partly added to by the conversion of transportation, and so the idea of future implementation is focused on emerging renewable energy [21].

The development of energy from renewable sources will solve many of the environmental challenges that are being faced by the growing world population and the demand for global industrial development, enabling the right paths to be followed in societal development towards energy security and, likewise, greater prosperity [21]. It is expected that by 2040 more than 60% of the energy sector investment will be within the area of renewable energy sources [22]. It is predicted that in Europe and the US, as much as USD 1 trillion (US short scale  $10^{12}$ ) in future investment and fuel costs for natural gas power plants through 2030 could be stranded by cost and technology competitive combinations of renewables and smart devices [22]. Therefore, it is crucial to develop the regulatory environment that will establish rules of conduct in the theater of attempts to decentralize the renewables energy market within both global and local blockchain networks, and proposing solutions for making regulations towards more electricity-based energy trade [23]. As a result of these trades, billions (US short scale  $10^9$ ) of connections will exist within the electricity grid, including customer-sited technologies, such as the 'Internet of Things (IoT)' and 'cloud' computing [24]. For the decarbonized energy future, it is necessary to create decentralized solutions, which have to bridge the gap between the centralized grids of yesterday and today to sustainable valorization of renewable energy in the decentralized grids of tomorrow. Such rapid changes associated with renewable energy solutions can be achieved with the implementation of digitalization and the use of blockchain technology [25]. Simultaneously, with the increase in the use of renewable energy sources, the IoT will be used to provide balance between the level of production and weather conditions [14,25] in synergy with the blockchain technology. The development of the number of devices connected to the IoT from 2015 towards the predicted usage in 2030 has been summarized to show growth from 15 billion in 2022 to ~30 billion (US short  $10^9$ ) (Source Statista, statistic portal, <https://www.statista.com/statistics/471264/iot-number-of-connected-devices-worldwide/> (accessed on 22 December 2022)).

Allowing the distribution of digital information without copying, blockchain technology opened the door to a new kind of Internet. It was originally developed and used for digital currencies, but recently it has been adopted in many other applications due to its great potential in data transmission [1]. The name blockchain itself consists of two concepts; "block" and "chain". "Block" refers to the transactions, while "chain" describes the way in which the blocks are connected. The chain is constantly growing, new blocks are created by each new transaction and encryption. Block creation process is called mining [3,4]. The concept of a single blockchain is based on a database, where data, information and documents can be stored, and is the complete list all transactions of, say, a cryptocurrency, i.e., the general ledger in which is written the chronological history of all transactions [7,8]. The advantage of this technology is that it is possible to transparently, inexpensively, and securely carry out transactions, verifications, and automations [16,20]. The system itself is greatly protected and designed to make it almost impossible to penetrate or manipulate data. This method was primarily developed for Bitcoin but is also used today in other virtual currencies [26]. Although it is primarily used to verify digital currency transactions, its application can be much wider, as it is possible to digitize, encode, and insert a given document in the blockchain. Blockchain has no central government and each change in blockchain is visible to everyone connected in the grid, and therefore all participants are responsible for their actions. This is illustrated schematically in the case of energy distribution in Figure 2. Blockchain presents a simple and ingenious method for free transmission of information between two or more distinct points, with costs arising only from the infrastructure [1,17,27]. The process is initiated through one party that creates a block, which connects up to thousands of computers distributed per network, and when the block has been added to the current list, a unique record is created with its own unique history [11]. In this way, falsifying a single record would mean falsifying an entire

chain in millions of network interlocked examples, which is, in today’s reality, effectively impossible [2,7,9].



**Figure 2.** Transactions of energy between energy sources and consumers, comparing centralized and decentralized generation and distribution systems, the latter being suitable for blockchain.

3.2. Centralized and Decentralized Blockchain Networks for Consumption

Blockchain security is bringing decentralization together with the introduction of cryptographic methods, as it is based on a time-lapse series of immutable records managed by a group of computers, containing connected blocks within a data chain, which is not the property of a single entity [25]. Besides the advantages in integrity, there are disadvantages in terms of the huge breadth of simultaneous logging required in the multi-ledger concept, as explained in Table 1 [1,7,9].

It is possible to carry out transactions decentralized, and blockchain greatly reduces costs and improves efficiency. Excluding a third party as an intermediary, blockchain also allows broad application with respect to the use of digital assets, designed for new Internet requirements, such as smart contracts, IoT and security protocols [1,25]. Nowadays, the blockchain technology provides a vehicle for a possible complete transformation of processes and business models, which traditionally relied on the collection of the costs of the transactions carried out. Cost collection cases include, music and movies streaming, art, news dissemination etc. Subscriptions for streaming are becoming redundant, as the benefits of blockchain technology can be applied for direct billing, eventually precluding large streaming services, such as Apple or Spotify [24,25]. Hence, blockchain enables micro transactions, which provide a greater spectrum of application in the online industry with payment of video services, e-books, video games for computers, or mobile phones, and similar transactions, becoming possible even with just small amounts, as small as 1/100 cent [9,24].

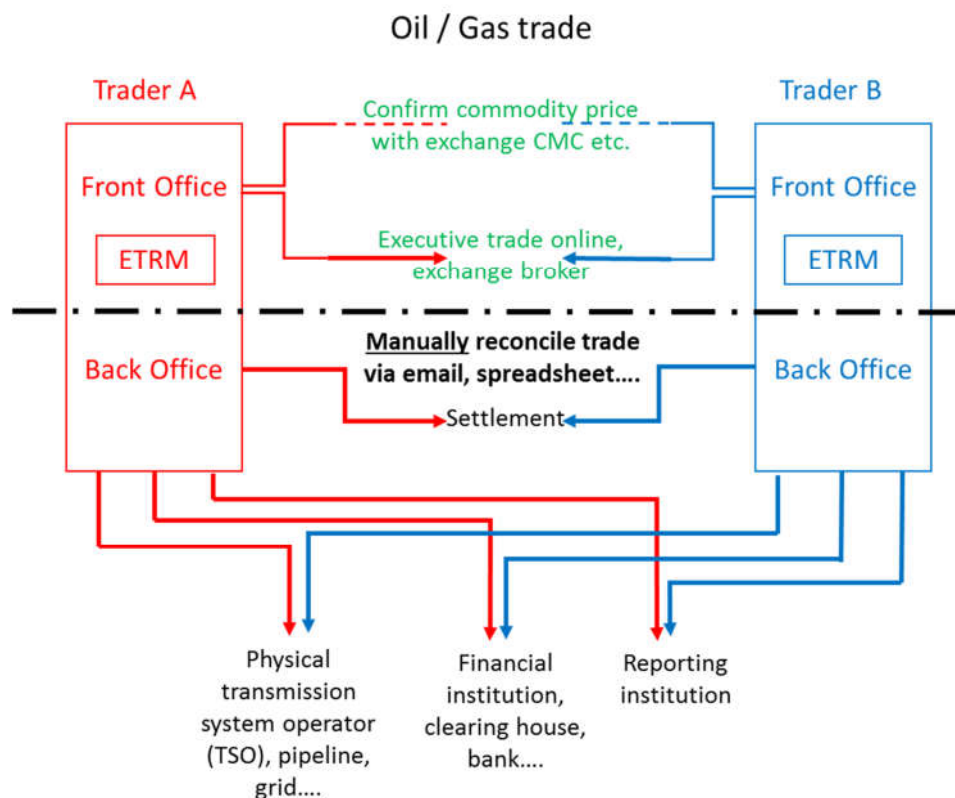
**Table 1.** Some disadvantages of decentralized blockchain technology based on scale limitations over time.

Criterion Name	Definition
High development cost	The implementation process of blockchain technology consists of many phases. These can be defined as design development, irrigation, maintenance and upgrading. The development cost required to manage a large system such as energy sector are quite high.

Lack of experience with large scale operation	The large energy supply chain includes many different partners and various activities that can give a rise to difficulties related to integration of blockchain technology. Integrating all activities into large supply chains a challenge.
Lack of acceptance by firms	Transparency, traceability, and distributed database that are part of blockchain might become a problem if some members of blockchain see integration as a lack of competition.
System scalability limits	Blockchain technology transaction speed is not as a fast as current speed (especially for photographs and full genomic data sets. While 7000 transactions are processed per second in a banking transaction, the average number of transactions in the blockchain is 7.
High set-up costs for development of infrastructure	A significant amount of software and hardware investments is required to successfully implement blockchain technology and retrieve real-time data. It is not easy for all partners in the network to bear such a cost.
Lack of global regulations uniformity	Blockchain technology has emerged in recent years and is not yet fully implemented. For this reason, there are still not defined regulations regarding the implementation rules under which it should operate globally. Furthermore, blockchain technology adoption may differ from one sector to another one.
Data storing and processing costs	The energy supply chain typically produces Billions (US short 10 <sup>9</sup> ) of participants, including prosumers, consumers, billing agents, energy partners etc. It may result in a huge amount of data that are being stored in blockchain, which are bringing cost to the chain.
Lack of operational and performance objectives	The fact that the technology is not fully mature, the performance outputs are not large enough, and the possibility of operationally unforeseen problems reduce the technology's acceptance in the sector.

Increasing the development of new technologies that utilize blockchain for integration will affect and change the stock exchange principle and the way that banking services and financial institutions operate, mainly making earnings on the fees for conducting transactions [26]. Stock intermediaries will no longer receive commissions, the principle of operation buy/sell will disappear, and bankers will become just financial advisers [11,13,25]. The information contained on the blockchain exists as a common, uninterrupted database stored simultaneously on all computers connected to the network with all records being public and easily verifiable [22], Figure 3.

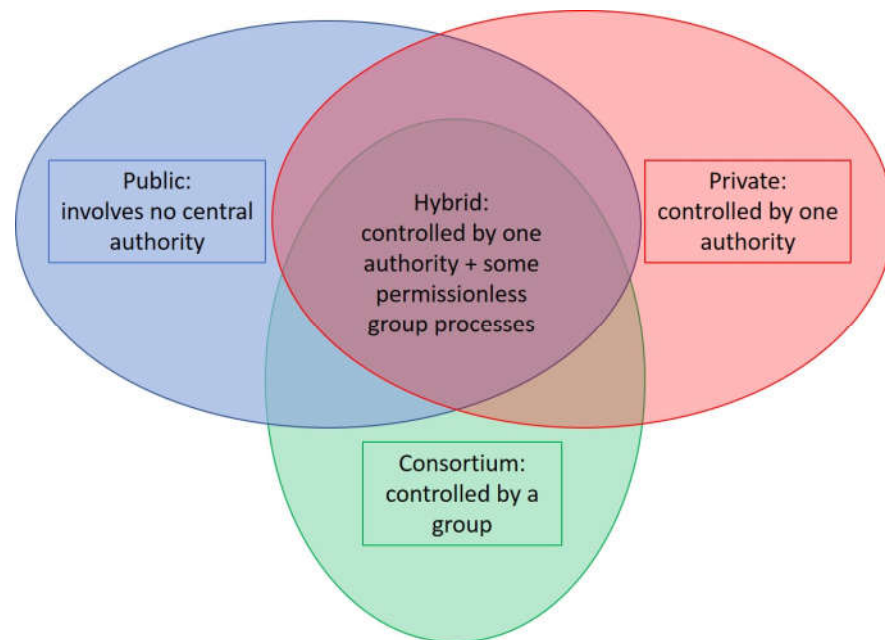




**Figure 3.** Energy trading and risk management (ETRM) blockchain-enabled trade using coin market cap (CMC) of electric currency versus old type of trading. (Source: Cleantech Group. Adaption from <https://www.cleantech.com/diving-into-blockchain-use-cases-wholesale-energy-trading/> (accessed on 22 December 2022)).

Blockchain can be divided into three types: public, hybrid, and private [1,9]. Public blockchain is a blockchain that can be accessed by anyone, as a user, developer, or communities, and so is fully transparent, with all transactions being public and accessible to all, recorded in the order in which they were carried out. It is fully decentralized and does not exist within any central control body. Probably the most well-known examples of decentralized public blockchain are Bitcoin and Ethereum. In private blockchain, information is not accessible to everyone, and transactions are private, visible only to members (of the coin in the cited example above), and therefore is used mainly by large business systems [1,4]. For someone to access it, it is necessary to get community approval. When blockchain is not completely decentralized, there is a body that grants or refuses authorization upon request for access.

Hyperledger and R3 Corda are examples of hybrid blockchain [13,17]. Hybrid blockchain has the characteristics of both public and private blockchain. In practice, it means that there is flexibility that allows some of the data to be public and visible to all, and part of the data remain private and visible only to some companies. This type of blockchain is used by business systems that distribute information in this way, with easy access control and without the need to create a classic database [25,28]. A distributed system for hybrid blockchain is a model where computers on the network communicate and coordinate actions forwarding messages, as presented in Figure 4.



**Figure 4.** Schematic presentation of decentralized (blue circle set), centralized blockchain design (red circle set), and consortium design (green circle set). Venn diagram group overlap (blue  $\cap$  red  $\cap$  green) represents the hybrid blockchain construct.

The decentralized type of blockchain lays its foundation on peer to peer networking (P2P) [25]. It represents a way of connecting a computer in the network without a central “node”, which node itself would normally be an individual central computer within the network [28]. There is no central computer or server, and each computer within the network communicates directly with another computer within the network, without an “intermediary” [25,29]. All transactions are verified and validated in the network alone, in which new blocks and chains are constantly growing. Due to decentralization and P2P networks, data integrity is additionally assured. Once recorded, data are almost impossible to manipulate or modify [10,30]. This is a way of facilitating and speeding up the operation and flow of data of the entire network, whilst at the same time, increasing the safety of the entire network, as there is no manipulatable central unit through which the flow is made [24].

There are three aspects of decentralization: (i) architectural—this aspect of decentralization determines how distributed a network is, and depends on the number of physical hardware entities that comprise the system independent of the large number of connected computers in the network, without compromising the operation of the entire network; (ii) political—this aspect determines which parties the network trusts, i.e., how many decision-makers are on the grid and how many individuals or entities control computers in the network; and (iii) logic decentralization—this aspect deals with consensus on the network, in that the network can have multiple variations of value for one thing requiring consensus.

Guided by this concept, the blockchain network is architecturally and politically decentralized; architecturally due to the fact that it consists of many computers located around the world, and politically due to being no one site that can control the operation of the network [13,24]. Although some parts of the blockchain community do not agree and are logistically decentralized, the whole system is working towards the same final goal [6,31].

When considering decentralized blockchain its main defining properties are: (i) error tolerance—as the whole system relies on a multitude of separate components makes it unlikely that the decentralized system will fail; (ii) resistance to attacks—decentralized

systems do not have a central impact of failure, and in the case of data attack, only part of a system will be affected, not the whole system as is case with current technologies, such that, as a result, the decentralized system is more resistant to attacks, and the attacks themselves require more resources; and (iii) inability to agree—disagreements between participants in the decentralized system are unlikely, as presented in Table 2 [11,13]. The main disadvantage of decentralization, however, is the loss of focus, due to the fact that there is an increase in independent decision freedom, and so main objectives can become ambiguous and their importance reduced [24]. Many decision-makers can act for a specific group within the blockchain with actions that are useful only for their segment and are not useful for the whole system [25]. In centralized systems, the central authority adopts all the decisions universally, and the rest of the system acts on those decisions. In decentralized systems, governance is agreed, and decision-making is slow and sometimes overdue. The duplication of jobs is inevitable; however, by their structure, decentralized systems are safe as a result of this, due to the concept of redundancy.

**Table 2.** Main properties of decentralized systems in blockchain technology [15,20,31].

Attributes	Type of Blockchain	
	Public Blockchain	Private Blockchain
Access	Anyone	Single organization
Authority	Decentralized	Centralized
Transaction speed	Slow	Fast
Consensus	Permission	Permissioned
Efficiency	Low	High
Data handling	Read and write for anyone	Read and write for a single organization
Immutability	Full	Partial
Energy consumption	More energy	A lot less
Transaction per second	Fewer	More
Attacks	High risk of collision	Reduced risk of collision
Infrastructure cost	High	Low
Native token	Yes	Not necessary
Speed	Slow	Fast
Examples	Bitcoin, Ethereum, Monero, Zachs etc.	R3 (banks), EWF (energy), B3B (insurance), Corda, Hyperledger Fabric.

Each system body repeats the same task, and this creates the necessary cost of resources such as energy and monetary reaction rate—decentralization leads to a loss of speed, i.e., prolongs the time of reaching consensus of a certain number of system participants [9,32]. The effort required to reach consensus is slowing down the decision-making process, further wasting resources and reduces the focus on common goals [24,32].

### 3.3. Consensus Algorithms in Blockchain Technology

As mentioned previously, due to the fact that it is a decentralized and distributed system, the information entered on the blockchain must be immutable, i.e., it must not be changed subsequently. Transactions that have been added must, therefore, be cryptographically protected, making non-encrypted changes impossible. Immutability is often mentioned as a characteristic of blockchain technology, because it makes a significant difference compared to usual databases where information can be changed and deleted as needed [33]. The question is how, and under what conditions, is this characteristic achieved? This is also the reason why these systems are also called systems of proof [34].

Consensus in blockchain is a process by which transactions and their records within the entire network and among all participants are synchronized, to ensure that the ledgers are updated only when they are verified by the participants and that they are always updated with the same transactions and in the same order [9,11,13]. The lack of trust inherent in blockchain systems forms the backbone of the need to reach consensus within the network. Due to the fact that the data once entered into the blockchain become immutable, and because each network participant can enter new, it is necessary that everyone participating in the maintenance of the network, i.e., performing validation, agree before entering data [25,27]. It is of great importance that all data be checked beforehand by finding a consensus, because the participants and their intentions may be unknown.

There are several methods on the basis of which consensus is achieved in blockchain systems. There is no doubt that new ones will emerge through experiments with a large number of cryptocurrencies and blockchain systems, as well as those existing methods being perfected over time. It should be borne in mind that changes and upgrades of these methods are frequent.

### 3.3.1. Proof of Work

This is the first method of reaching consensus, which is also the most widely used. In order to verify the “page of the book” or block, the participant who maintains the network—a node—has to solve a very complex mathematical problem [27,35]. The purpose of solving these mathematical problems lies only in the fact that it simulates the operation, i.e., that the device consumes electricity when considering the topic of blockchain in respect to energy management. In return, the node is rewarded with a certain amount of cryptocurrency including the cost of transactions [36]. This process represents so-called “mining”.

Participants of a network based on this method can choose to be miners. Electricity consumption is also a good incentive for miners not to cheat the system. The only way that miners, i.e., participants who maintain the network, could cheat the system is with 51% of the total computing power of the entire network [11,17,24]. Even then, it is impossible to change already entered transactions and it is only possible to stop subsequent transactions. Considering the amount of capital that needs to be invested, there is no economic logic to going against the system [9,21]. The more computing power a node has, the more likely it is to be the first to solve a mathematical problem, and, in turn, get the reward faster. This is also the reason why, in blockchain systems that are based on Proof of Work (PoW), there is a large association forming a mining pool. However, this method has its drawbacks, because the larger the network, the more energy is needed to confirm transactions, and the more time it takes to confirm transactions, which further means a lower number of transactions per unit time [36]. These flaws are also the reason why this method is questioned, as well as whether it makes economic sense, for example, for cryptocurrencies based on it to be used for exchange. It is still, however, the most widespread [34–36].

### 3.3.2. Proof of Role—Proof of Stake

With the Proof of Role—Proof of Stake (PoS) method there is no mining, but as the name suggests there is proof of stake. Some nodes will process transactions, while others will confirm them. In order to avoid or punish attempts at cheating, nodes must lock a part of their funds in a virtual safe with a simple digital signature on ownership [35].

The network uses a lottery system to select a participant to confirm the data entered in the database based on the participant’s role. In case a node tries to cheat the system, its stake will be taken away. Similar to mining, the higher the stake, the greater the chances that someone will validate a block of transactions and create the next one, and, therefore, have more to lose if they try to cheat [37]. This type of system is often the target of criticism that it is actually centralized, because the longer someone is on the network, the greater their share, and thus the greater control they have over the network. The most famous

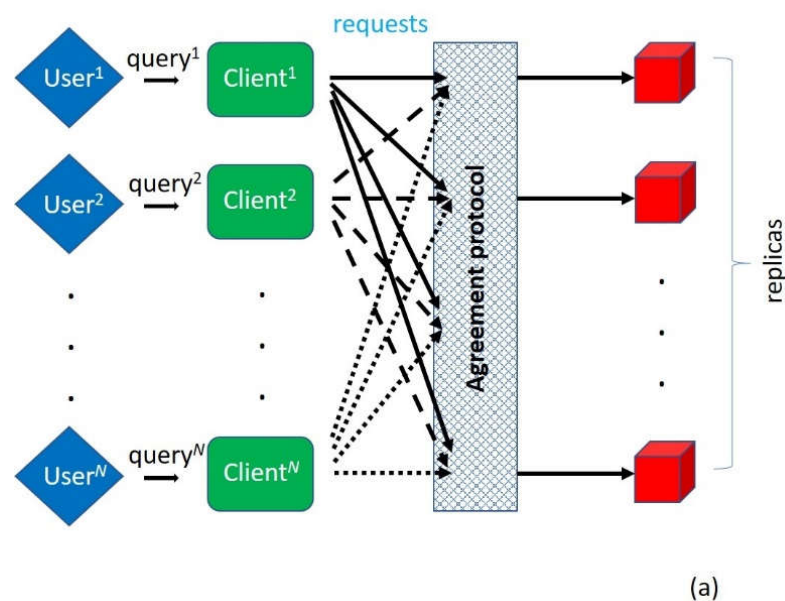
cryptocurrencies based on this method are DASH, NEO, PIVX, and NXT, for example [9,37]. The advantages of this method are that it brings a greater number of transactions per unit time with faster confirmation of transactions.

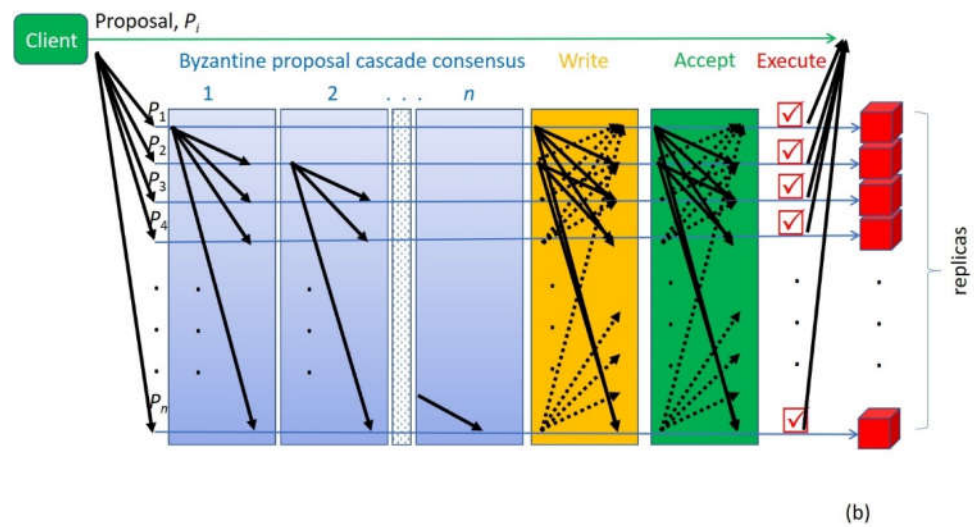
### 3.3.3. Practical Byzantine Fault Tolerance

Practical Byzantine Fault Tolerance (PBFT) is the most common method of reaching consensus in the so-called industrial or private blockchain systems, and is considered one of the possible solutions to the aforementioned allegory. With this method, each network participant maintains their internal state [37]. When a message is received from the “messenger”, the information from the message is used along with its internal state and the operation is executed. The performed operation enables the participant to make a conclusion about the received message. After that, the participant’s decision is shared with the other system participants, and a consensus is reached based on all the decisions sent by the partaking participants. Using this method, the consensus is achieved much more easily, but at the expense of anonymity. This is the reason why it is used by membership-based, permissioned blockchain systems. Some examples are Hyperledger, a Linux initiative for the development of industrial blockchain systems with a large number of Fortune 500 companies as members, and Ripple, a private and closed blockchain system for financial transactions currently implemented by many banks [37,38].

All Byzantine fault-tolerant (BFT) protocols assign each client with a unique service history that places and also executes in a determined way, as presented in Figure 5, in which a schematic is shown to represent a BFT replication system. In such protocols users initially send requests to replicas using a well-defined client library. Orders on clients’ requests are in the agreement protocol, executed by replicas within the precise order from the disk [6,13]. There are two distinguishable types of Byzantine fault-tolerant protocols: agreement-based protocols, and quorum-based protocols.

A property of the BFT consensus mechanism is its concept of the use of replicated data by voting by replicas for the change in the system for providing signing and encryption exchange capabilities between clients and replicas. This approach reduces the number of messages and their size, ensuring at the same time data security of Byzantine faults and reduction of overheads for performing services [6,36].





**Figure 5.** (a) Abstract of a PBFT replication system. Users send requests to replicas via client interfaces (with well-defined client library). Replicas together run an agreement protocol to obtain an order on clients’ requests, and then each replica executes them in its stated application. (b) Message patterns of BFT.

### 3.3.4. Federated Byzantine Agreement

The Federated Byzantine Agreement (FBA) mechanism of blockchain consensus assumes that nodes or parties in agreement already know each other and agree between them the importance of each member in the consensus, with the most important defining the validity of transactions [6,16,37,38]. This mechanism is used typically for financial transactions with enabling within a second cross-border transaction. This is contrary to such present trade mechanisms, which require days for the same transactions.

The type of applications that will be used in blockchain implementations defines the consensus protocol needed to prevent possible threats to the chain integrity. For the public blockchains, which are permissionless, with a very large number of participants in consensus, there is a vigorous computational system employed, which sacrifices conclusiveness of transactions [37,38]. As opposed to public, the private and permissioned blockchain consortia often use less scalable but higher throughput models that are much faster.

For determining the most suitable trading platform and right consensus model, it is necessary to observe factors regarding the chosen network scale and participants’ relationships, as presented in Table 3. Furthermore, network performance and its confidentiality must be evaluated.

**Table 3.** Types of mostly used blockchain consensus agreements.

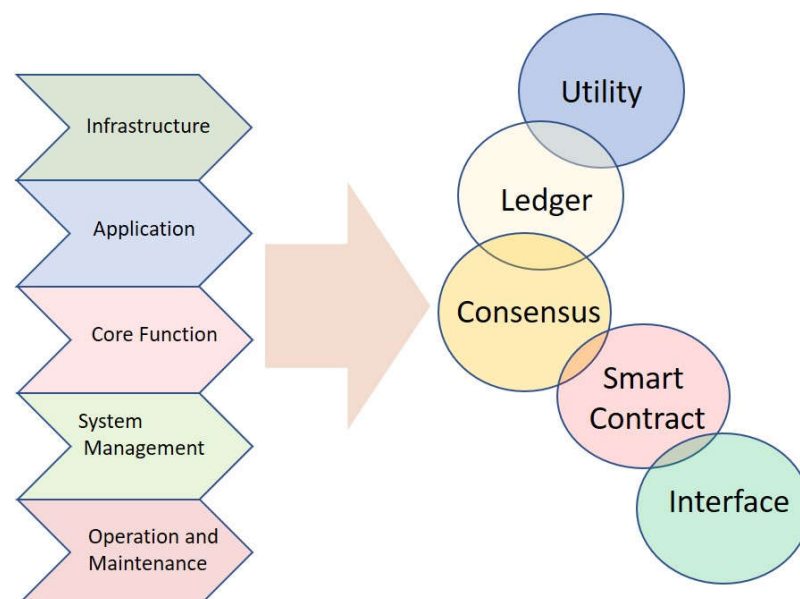
Properties of Block-chain	Federated Byzantine Agreement (BFT) and Variants	Practical Byzantine Agreement (PBFT)
Type	Permissioned	Permissionless
Tokens needed	No	No
Peer network scalability	Low	High
Network trust	Semi-trusted	Semi-trusted
Tolerance range	≤33%	≤33%

### 3.4. Blockchain of Energy Trade and Risk Management

Within the oil and natural gas market, many supply chains are connected in extracting, refining and distribution of products [39]. With the use of blockchain in respect to

energy distribution, any transformation of information will be factual and highly regulated [30]. This is important for industries that are taking part in transactions within, for or outside the energy industry, such as banking or hedge funds [13,30]. Companies which coordinate energy trading activities within Energy Trading and Risk Management (ETRM) transact using counterparty networks using software that will support commodity trading, enabling the flow of information between each energy production segment, bringing together a large number of participants, including manufacturing, refining, distribution, and retail companies, which trade between themselves defining the pricing, logistics and risk management information [21,40]. Trade with blockchain finalizes settlements between trading parties, in which digital (IT) systems harmonize trade data, helping energy companies to make more efficient and faster trade systems [41]. There is ongoing interest for continuous development of blockchain applications that can eventually restore these systems should there be a catastrophic failure, through recognizing patterns and so improve transaction testimonials in banking [30,40].

A blockchain such as Ethereum is capable of keeping data of all customers at one place, and Interbit is capable of creating a single blockchain for each customer while they are all interconnected with the main blockchain. In this way, adopting the Interbit structure, a more flexible authorized system is obtained, in which it is possible to provide certain information exclusively to counterparties with the possibility to work on more than 100,000 transactions per minute [12,16,41]. Previously, before blockchain, buyers would generate an appointment, making a request quantity of product at a certain price, delivery place and time from an upstream seller, and nominations would be sent in emailing systems in pdf format by attachment, which, in turn, would be fed into software. Each updating under such a system requires all participants in a trade to search for the original pdf to update it with repetitive manual data entry, which is complex, prone to error and expensive [9,16,32]. Furthermore, the transaction time increases when the trading parties are not subsidiaries within the same company. Long settlement time resulting from the trade process increases product costs with the necessity that counterparties provide committed capital that can be released only when the trade is settled, which negatively affects any reconciliation process [31,34,39]. In contrast, using a blockchain system, reconciliation is part of the process, and errors that occur during the addition of data become automatically eliminated, since entries containing data that are not aligned do not belong to the multiple simultaneous copies of the trade records [21,38,42], as represented in Figure 6.



**Figure 6.** Main characteristics of a blockchain technology.

In a simplified energy trade, therefore, both buyer and seller negotiate and agree on the price of a product or service, being also simultaneously connected to a consulting price exchange intermediary, both entering details of the transaction onto the ETRM system, and so both mutually confirming the trade and informing their broker [4,36,40]. A transparent and synchronized distributed ledger then allows for instant settlement and a credible record of energy estimates when they were submitted together with information about parties that signed the trade agreement, simplifying settlement, and consequently reducing energy trading costs [40,42].

#### 3.4.1. Peer to Peer Trading

Initially, Visa and European bank technology adopted the peer to peer (P2P) trading concept in 2016, which is used nowadays for money trades across international borders [43]. Therefore, the P2P way of trading works in smaller environments where a small number of transactions take place. Within a micro-grid, as a decentralized energy system, P2P is suitable for performing transactions. This type of trading is often associated with the use of smart contracts, where transactions are performed automatically, and trading becomes faster [34,43].

The direct or P2P trading concept is achieved through the transaction platform using a decentralized system for saving transaction data [4,30]. Achieving decentralization requires an actual network of computers constantly exchanging information and executing complex algorithms at high speeds [34,40]. Scaling this technology to a system that can handle thousands of transactions per second is the challenge that needs to be met.

After success in the financial market using the Interbit system, P2P methodology became used in the trade of oil and gas. Although renewable sources account for just a small share of global electricity generation, they are rapidly displacing fossil fuel-based production [42,43]. In 2017, more than 50% of newly added production capacities were recorded in investments in renewable sources. To meet rising needs of electricity demand, new sustainable renewable electricity production technologies are developing within peer to peer blockchain trading platforms, which enable direct selling, say, of excess solar power produced in households to neighbors, and this is possible without any intermediaries [7,13].

Several drivers are pushing renewables toward adopting blockchain and smart contracts. Installed costs are plummeting, with wind turbines decreasing by 30% and solar panels by 80% already as far back as 2009, allowing these to bid competitively against fossil fuel generation, according to the International Agency for Renewable Energy Sources [44]. In an organized system, there must be a kind of agreement between producers and consumers of energy [7,19]. The trading company, BC-Energy Ltd., a subsidiary of Borsodchem, Hungary, trading throughout Europe, operates such a system by contracting generation through smart contracts [45].

A smart contract is a term used within blockchain to describe a computer program capable of facilitating, executing, and enforcing the negotiation or execution of an agreement. This achieves a transparent and fair agreement between the contracting parties. Therefore, all members in the distribution and transmission system are bypassed and the producer and consumer are directly connected, which reduces the price of electricity for the end user, and the system benefits the producers of energy from renewable sources because it enables them to make a bigger profit. The process is highly synchronized and automated, serving as a supplement or replacement of traditional legal contracts, with terms that are recorded via codes and written in a block. Smart contracts can also automatically initiate transactions between network participants, i.e., it allows producers to feed excess energy automatically into the network via a smart blockchain meter. Electric energy (termed in data) is automatically encoded in the blockchain, with algorithms that execute the renewable energy transfer and delivery to the customer using the P2P method [45].

#### 3.4.2. Tokens

Technically, “token” is another word used for “cryptocurrency”, but commonly confined to describing all cryptocurrencies except Bitcoin and Ethereum (although technically



they are also tokens) [9]. They describe certain digital assets that “run” on the blockchain of another cryptocurrency and can be traded or held like any other cryptocurrency [46,47]. Tokens have a huge range of potential functions, from helping to enable decentralized exchanges to selling rare items, for example in video games. Some cryptocurrencies, such as Bitcoin, have their own dedicated blockchain, whereas decentralized finance (DeFi) tokens, like Chainlink and Aave, run on or use an available existing blockchain, most commonly Ethereum [48]. Tokens in the latter category help decentralized applications do everything from automating interest rates to selling virtual real estate [47,48]. DeFi tokens represent a new world of cryptocurrency-based protocols that aim to reproduce the traditional functions of the financial system, including lending and savings, insurance, and trading, with such functionalities emerging in recent years. These protocols issue tokens that perform not only a wide range of functions, but can also be traded or held like any other cryptocurrency [48,49].

Governance tokens are specialized DeFi tokens that give owners a say in the future of the protocol or application, which, being decentralized, have no boards of directors or any other central body [49]. The popular savings protocol Compound, for example, issues a token called COMP to all users. This token gives holders the right to vote on how Compound is upgraded. The more COMP tokens you have, the more votes you get [49].

Non-Fungible Tokens (NFTs) represent ownership rights to a unique digital or physical asset. They can be used to make it harder to copy and share digital creations, a problem understood by anyone who has ever visited a ‘torrent’ site full of the latest movies and video games [50]. They have also been used to release limited numbers of digital artwork or sell unique virtual assets, once again such as rare items in a video game [50].

Security tokens are a new class of assets that aim to be the crypto equivalent of traditional securities such as stocks and bonds [51]. Their main use case is selling shares in a company, much like shares or fractional shares sold through conventional markets, or other businesses, for example, real estate, without the need for a broker [51]. It has been reported that major companies and startups are exploring security tokens as a potential alternative to other fundraising methods [51,52].

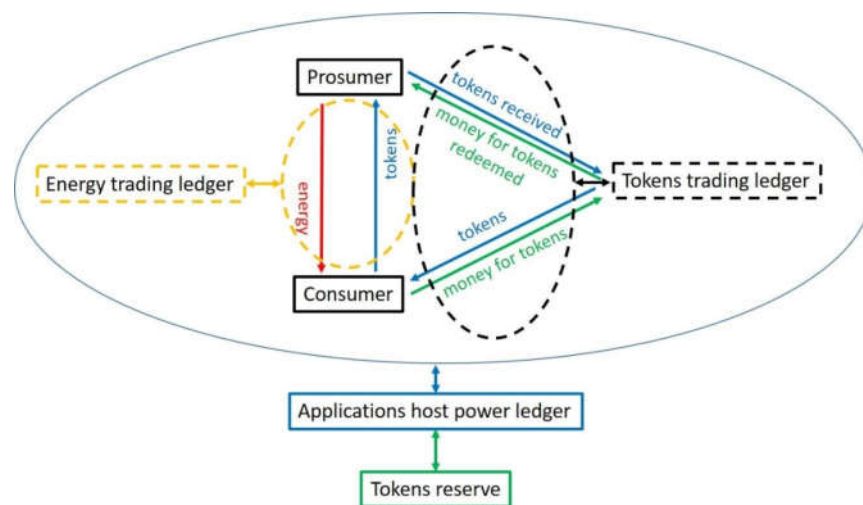
### Tokens of Electrical Energy

Tokens can be relatively easy to create and issue, and can be available to anyone with a mobile phone and Internet connection, enabling investments in a democratic way, without bureaucratic obstacles, with the use of basic technical literacy and small amounts of currency [52]. The biggest drawback to this concept is that the ecosystem of apps that support it (mobile apps, wallets etc.) is still in development, although the situation compared with just a few years ago is improving greatly. Unlike crypto currencies, which do not give the holder any rights, a crypto token is a portable unit that expresses the measure of rights to a property or service embedded in the token, derived from a smart contract [49,51]. The token is transmitted in real time digitally via a blockchain network, without intermediaries and authorization of third parties offline.

In Australia, this approach to energy market, adopting tokens, has given rise to many pilot projects that connect renewable energy sources with blockchain projects sponsored by the Australian Government, which enabled one of the largest energy utilities in Australia to implement tokens in monitoring and trading energy [5,7,16]. Power Ledger (PL) is an example of an Australian energy trading platform, founded in 2016, that enables the decentralized sale and purchase of renewable energy with the application of P2P contracts via blockchain [53]. PL does not require the use of special hardware, but it is necessary to install a smart meter so that data on energy production and consumption can be processed and further traded using software trading in tokens [51–53].

Vouchers of electrical energy from renewable sources, are appearing under many different names globally, such as Sparks, Iskra etc. [54]. They can be redeemed from the energy producing company or competent authority, and electricity buyers could trade one unit of energy (kWh) of solar power for a defined number of tokens at a given price [54,55], and

shown schematically with extended ledgers as might become the case in practice, Figure 7. A vendor who received tokens for the energy they produce and sell, can obtain currency, with each transaction of purchased token and electricity transaction being recorded on the blockchain, containing the record of electrical energy movement from vendor to buyer [52–54]. Therefore, blockchain allows connection of devices that generate electricity (solar panels, heat pumps etc.), including storage devices (various types of battery), and manages the flow of electricity from producer to the nearest location where it is needed encompassing the highest bidder. Such a closed loop obtained within the blockchain circulates electricity from the producer to the consumer via the shortest route, enabling consumers also to become producers (prosumers) of the renewable electricity in transmission [52]. However, since regulations governing electricity at the moment do not permit electricity trading via the P2P model, it is necessary to create a platform in the online marketplace, i.e., a microgrid that will enable prosumers to sell excess renewable energy produced in the form of solar, wind or other types of renewable energy tokens [45,52,54].



**Figure 7.** Diagram of renewable energy trade with use of energy tokens, pre-empting the use of blockchain.

### 3.5. Application to Decentralized Energy and Micro-Generation

In the traditional electricity distribution grid, the end user has no option other than to be a consumer only, and the flow of electrical power was one-way, i.e., from utility to consumer [55]. Renewable-energy sources have brought into the picture a new class of participants that are prosumers in the electrical grid, where prosumers are those who can consume as well as produce electrical energy with financial incentives, environmental awareness, and low dependency on energy suppliers [56]. In this portfolio the microgrid concept emerges, which integrates all local renewable-energy sources, and enables transition from a traditional centralized grid to one that is decentralized [55,56].

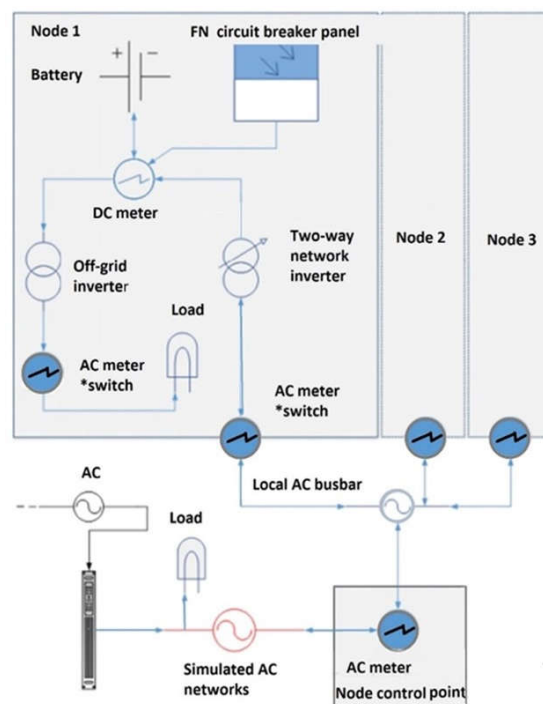
A microgrid is a small-scale, locally controlled power system, which integrates the renewable energy generating source, simultaneously managing its balance between local load and power generation [52]. This model enables prosumers to trade electricity with their neighbors forming a local grid within a collection of autonomous microgrids that are interconnected. Microgrids have the capability of handling power flow in two directions, i.e., from the microgrid to the main grid and the main grid to the microgrid, so as to use its on-site generation optimally.

The operation of microgrids can be run in an isolated manner, called islanding mode, which is opposite to the in-grid connected mode involving hierarchical management; each level of hierarchy is made of loops, in which higher levels are forwarding benchmarks to the lower levels, with the latter having faster response [52,54]. The primary level is used

to adjust the current benchmarks in the network regime and voltage in the island mode [55,56]. Hence, forecasting is necessary for all renewable energy plants, which is also the main problem due to unpredictable environmental conditions, and therefore incorporating a weather forecasting framework on day-ahead trading is difficult [57,58].

As mentioned in the previous section, to achieve network management and control over production and consumption data, it is necessary to install smart devices, which means that the network itself automatically becomes “smart” [58]. The use of blockchain technology is only possible with the existence of smart devices embedded in the network, because data are actually traded with this technology. This applies primarily to producers, while consumers can buy excess produced energy from producers even without measuring devices, but then the balance that is to be achieved in the micro-grid is not sufficiently measurable and transparent. Figure 8 shows a schematic of hardware connected to a micro-grid system. This demonstration is based on laboratory conditions as in a test device for power generation and data exchange, and includes components of power generation, storage, measurement, consumption, and the simulation of alternating current. The following gives a brief description to understand the function of using hardware and software as a link between a micro-grid and blockchain technology.

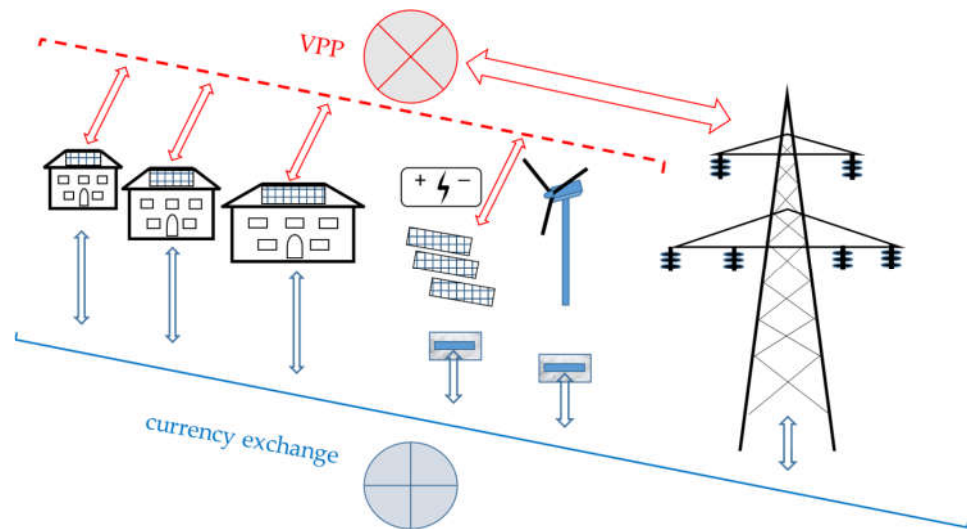
From the perspective of the distribution system operator, the main problem with a high penetration into the grid of renewable sources is voltage control. Smart inverters can participate in voltage regulation, by absorbing reactive power at high voltages, and then injecting it back at low voltages. In a combined way, it is impossible to meet the requirements in all cases for both voltage control and the requirements of the virtual power plant reaching the adjusted values of active and reactive power. The model presented in Figure 8 shows the operation of the micro-grid either in so-called island mode (in isolation) or connected to the public grid. Each node includes an AC and a DC subsystem [55]. The DC subsystem is made of 12 V batteries (300 Ah), a solar panel (130 W) and a power regulator for charging the battery. Two converters (AC to DC) and a battery charger are located in the AC subsystem. Inside the island there is also a special access node allowing access to follow the characteristics relating to the converters.



**Figure 8.** Schematic presentation of micro-grid infrastructure (according to [55]). \* Refers to an externally controllable item, e.g., an operatable switch.

### Virtual Power Plants (VPP)

A VPP represents a medium-scale power generating unit that is also a flexible power consumer and storage system [59]. Today, renewable power plants are normally included as sources, and even individual consumers are offered the opportunity to access the power generated, which can be either directly generated from source or transmitted as virtual power generation from an intermediary [58,59]. Power plants that are based on renewable natural sources cannot be manipulated in the same way as conventional generators, because they currently predominantly depend on circumstances that are outside the domain of human influence, and due to this VPPs are developed with the use of artificial intelligence such that one VPP can in reality contain several microgrids to provide the desired flexibility and coordination [59]. The control system for the VPP consists as the response to the possibly conflicting demands of the various microgrid members. In this collective manner, a VPP can operate and behave like a conventional power plant, drawing from a large number of geographically dispersed renewable source power plants being connected without any reduction of the power variability between them [60,61]. In this structure it is important to create a balance of resources, as excess amounts of energy provided will add to the complexity of VPP control. Therefore, the VPP is not physical, but rather a virtual entity that contains commercial and technical units that highly depend on its software and communication links within it, Figure 9. Thus, the VPP's management, when based on a smart grid, needs to contribute to a greater and better integration of renewable sources into the system [60–63]. As a result, a number of outstanding questions need to be resolved regarding integration of distributed generators and providing their voltage increase control for the main network. Presently, VPPs are centralized power plants that utilize cryptocurrency and exchange virtual power to monetary value, with each cryptocurrency using its own blockchain, as presented in schematic in Figure 9.



**Figure 9.** Schematic presentation of a distributed renewable energy grid in which prosumers produce electric energy with, e.g., photovoltaics (PV), wind, and storage, and are connected as a virtual power plant (VPP)  $\otimes$  to the decentralized larger grid with currency exchange  $\oplus$ , both linked via blockchain.

### 3.6. Regulatory Development for Blockchain Renewable Energy Grid

The increase in technology development for production of renewable energy sources will lead to ever increasing decentralization in the market due to the increasing number of users involved. In parallel internet systems managing their sourcing are expected to become more resilient so that it will be increasingly difficult to launch attacks and commit fraud [64]. The overseeing role requires regulatory control and standards, necessary for

implementation in all countries to define sustainable standardized protocols for communicating and exchanging information with clearly defined semantics and syntax [65].

Regulatory support is important in connecting the electricity grid of the future in a sustainable way, since blockchain is new technology and at the present time is not yet fully recognized globally in the electricity market [30]. As the more developed countries and industry leaders continuously invest in renewable energy generating plants, development has to be aligned with efforts to educate regulators in order to help them embrace the results of research into the implications and applicability of the blockchain model.

One of the more important issues addressed in regulatory is related to cyber security in centralized and decentralized blockchain networks [4,13]. Different types of attacks are possible, ranging from physical hardware to software systems, but since the management of energy systems is largely based on data estimation, generally one of the most dangerous means of attack is the insertion of false data and control of the grid. If an integrated VPP were to be hacked, it would affect the entire power grid. An economically attractive and feasible P2P microgrid market can be established only if there are many interested parties wanting to trade energy [45,64]. The microgrid should have uniform voltage within the operating system, working aligned and synchronized with a traditional grid. For the exchange of power between the distributed energy within the microgrid, the recovery of the AC frequency and voltage must be controlled at a higher level in the grid hierarchy, and regulation is needed [62].

New and modern regulatory needs to be accepted on a governmental scale to enable better performance of information and communication technology (ICT) and make it equally available for all participants, making for a clear and coherent renewable energy market [6,30]. In order to have financial motivation to develop integrated microgrid energy markets, the pricing of energy should be adjustable at the same instant as energy generation, i.e., during surplus with decreasing energy price and with increasing price when under large demand creating energy insufficiency [43]. Energy supply, climate conditions and demand data can be checked on the local, state, and continental level, enabling energy transactions that are secure and transparent [47,65]. Blockchain technologies ensure that both big government energy agencies and small prosumers allow public to have access and confirm transaction files.

### *3.7. Further Expansion Opportunities and Potential Roadblocks for Blockchain*

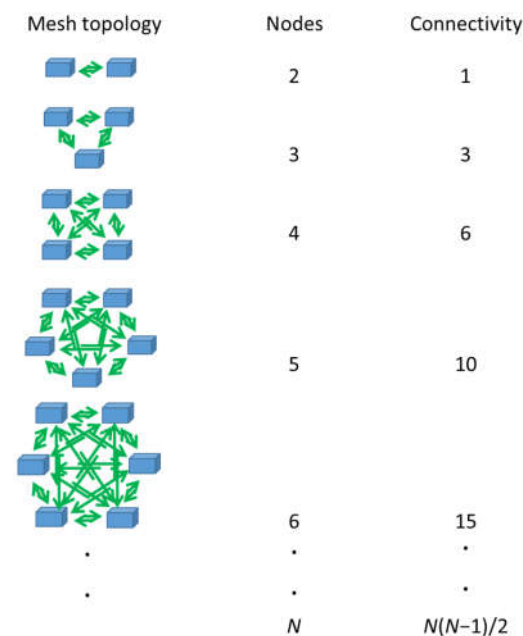
Bitcoin launched as the initial “trademark” cryptocurrency without any bank regulating it, starting as “mining” organized by a few hundred so-called “hobbits” that were miners [9]. Miners, as described earlier, use multiple computers to verify transactions and solve cryptographic mathematical problems, by combining transactions into “blocks” and adding them to the chain of inventory (blockchain), which is the public record of all transactions, and then trading them for money. In the response to the expansion of cryptocurrency, massive computing farms have spread worldwide, that operate all day, consuming electricity. Mining of the largest cryptocurrencies requires a vast amount of energy to function, thus creating a huge environmental problem, eventually posing a threat to the Paris Agreement on global warming mitigation [9]. This energy wastage cost is backed into the system, passed on via transaction fees, such that end-users of networks pay for them, with possible fatal lack of viability in the future [17,20,25]. Due to this fact, the trend is moving toward establishing cryptocurrency computing farms that use only solar energy or comparable renewable energy sources, such as exemplified by Genesis Mining and Ethereum in the cloud [41]. Modern blockchain is expected to offer miners that use green energy sources increased incentives, such as more cryptocurrency, or even deny payment to miners that reject to use renewable energy sources. In the dynamic and fluctuating, potentially conflict-ridden, business environment surrounding cryptocurrency development, the benefits of blockchain need to be enhanced, properly managed, and controlled [11,48].

Apart from entertainment, banking, and energy, other trading platforms are clearly open and ready for the application of blockchain. This is particularly so in the area of raw materials sourcing both for high value specialties, such as rare earth elements needed for batteries and control systems in the quest for further electrification in society including transportation, and industrial commodities, such as minerals and ore for construction, and the materials sourced from them, including metals, such as copper, aluminum, and steel [7,8].

As an example, in the case of the metal industry, particularly, the utilization of blockchain technology with its distributed ledger can connect all processes involved in the value chain from the mining of ores through the processing of metal products, their sampling, shipping, and delivery with transportation warehouses, and, finally, payments. Later in the product lifetime also comes recycling and potential re-valuation in the circular economy. All these steps consume energy, and so the metal and metal-working industries are well positioned for integration into blockchain, initially managing energy trading, as discussed in this paper, and then expanding to trading across all the linked processes within metals handling [19,20].

Modern industries, which choose to use blockchain, participate in a commercial tool by sharing their data base with all participants in the market in a transparent and secure manner. The use of digital blockchain technology, in which all information will be stored, will, as mentioned previously, remove the threat of forgery of, for example, certificates of laboratory analysis, documents and receipts from energy acquisition, food, cosmetics, pharmaceuticals, luxury items, and simply materials in general.

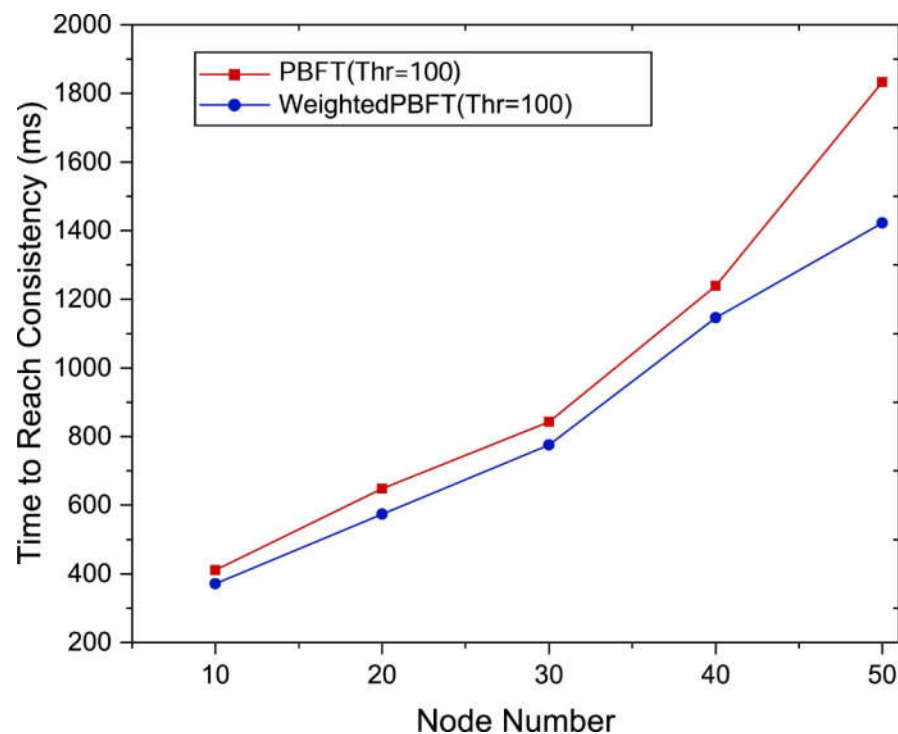
A rapid glance at Figures 2 and 5 reinforces the conceptual understanding of the complexity of interconnectivity, and the resulting energy consumption involved. Figure 10 builds a schematic of the expanding connectivity based on the simplest of transaction protocols, i.e., a signal from one component computer in the multicomponent network and a corresponding return confirmation signal to establish the ledger replica process [63,64]. The connectivity follows the mesh topology, and Figure 10 shows the minimum connectivity needed to maintain a link between all nodes, i.e., every device (node) is connected to another device (node). The protocol used in this case is termed an ad hoc configuration protocol.



**Figure 10.** Mesh topology with minimum necessary connectivity for  $N$  interconnected devices.

If the network is expanded to  $N$  nodes in this way, the number of connections required by each node is  $N-1$ . Thus, for  $N$  nodes the total number of connections is  $N(N-1)/2$ , which is written mathematically as the combinatorial  ${}^N C_2$ , and shown to follow the series in Figure 10, namely 1, 3, 6, 10, 15, ...,  $N(N-1)/2$ . Thus, it is easy to see how the energy for connectivity increases as the blockchain participants increase.

The protocol complexity, as shown in Figure 5, rapidly increases the signal number needed to achieve a recorded transaction and confirmed multi-ledger replication. Consider each connection link must transmit, say,  $i$  signal exchanges, then the total signal exchanges between all nodes to fulfil a given agreed blockchain protocol follows  $(N(N-1)/2)^i$ . Jiang 2018, [66] estimated the energy of transmitting 1 bit as 10 pJ, by considering the capacitance per unit length transmission, both by cable and within a solid state device, operating typically at 1 V. If, instead of cable, optic fiber is used, the estimated energy consumption per bit of optically amplified transportation in the ideal case and limited by the Shannon bound is estimated to be 4.4 fJ [65]. Feng et al., 2021 [67] showed a typical blockchain network protocol time consumption to reach consistency as node number increases, Figure 11, for a practical Byzantine fault tolerance (PBFT) and weighted PBFT, both at a tolerance threshold of 100.



**Figure 11.** Consensus time as a function of node number. Reused from [67].

Assuming as a first approximation that Figure 11 shows linearity, a function in the form  $t$  (ms) =  $(1,000/50)N = 20N$ , allows an approximate estimate of transmission time. Thus, considering a USB 3.0 port to support a transmission rate of ~5 Gbps over a clock cycle ~200 ps, the energy consumption can be estimated via the number bits transmitted, i.e.,  $5 \times 10^9 t = 5 \times 10^9 \times 20N \times 10^{-3} = 100,000,000N$  bits. Given the estimate of energy consumption above for a highly efficient optic fiber connectivity at 4.4 fJ bit<sup>-1</sup>, the energy consumption for one consistency operation is  $4.4 \times 10^{-15} \times 10^8 N = 10^{-7} N$  J. Although this seems a relatively small energy consumption for a single operation, a typical blockchain transaction is remarkably slow due to the huge number of operations required. A highly efficient blockchain operator, such as Bitcoin, completes only 4.6 transactions per second, and this is due to the immense mining required [61,62,67]. If it can be assumed that a smaller

operator of blockchain were to make transactions with far less mining, say at  $\sim 1,000$  per second, then the power consumption would be  $10^{-4}N$  W. For a 24 h operation using 100 nodes, this would bring an energy consumption of  $86,400 \times 10^{-4} \times 10^2 = 864$  J for data transmission only. A typical desktop computer system consumes  $\sim 200$  Wh [68] during dedicated operation, i.e.,  $200 \times 24$  J per 24 h = 4,800 J. Thus, in total, for the operator suggested above the energy consumption per 24 h is  $\sim 5.7$  kJ, equaling an annual consumption of  $\sim 2$  MJ.

The very rough estimate considered here for small-scale blockchain use can be compared with the larger scale estimate for cryptocurrencies reported recently by Kohli et al. [68], in which a listing taken from a number of references is provided for the electrical energy consumption of Bitcoin and Ethereum in relation to whole countries' electrical power consumption. Bitcoin at 135.12 TWh is in line with countries such as Malaysia and Sweden, with Ethereum on a par with Switzerland. At a combined energy consumption of 0.81% (190.13 TWh) of world energy consumption (23,398.00 TWh), these blockchain energy consumers are simply gigantic [61,62]. Their combined consumption is close to that of the total of global data storage centers, they being  $\sim 1\%$  of world electricity consumption [68]. A large multinational company trading in raw materials will at most consume the energy of a small data storage facility. Nonetheless, such increases in electrical energy being consumed is likely to arouse regulatory interest, and it is expected, for example, that EU rulings will soon be considered.

Further study by Kohli et al. [69] reveals that in contrast to the big player Bitcoin and Ethereum, smaller cryptocurrencies, such as IOTA (FPC) and Hedera (Hashgraph), consume typically between  $10^{-4}$  and  $10^{-2}$  kWh, respectively, the latter thus consuming  $\sim 36$  kJ per hour =  $\sim 315.4$  MJ per year. This gives some credence to the value proposed by the short analysis above, starting from first principles, of  $\sim 2$  MJ per year for a single blockchain active company.

Despite the scaling comparison, even summing smaller applications of blockchain will undoubtedly bring a negative environmental load unless alternative strategies are developed [69,70]. The literature in general addresses the protocol strategies, the potential identification of redundancy and, of course, sustainable energy sourcing. However, quantum technology may provide an answer to improved energy efficiency. Bennet and Schakib in 2019 [71] propose a quantum-enabled blockchain architecture via a consortium of quantum servers. The network utilizes digital systems for sharing and processing information, combined with a fiber-optic infrastructure connecting quantum nodes (devices) transmitting and processing quantum information. They claim an energy efficient mining protocol enacted between clients and servers, using quantum information encoded in light, considering the vulnerabilities and benefits of quantum computing toward blockchain applications. Quantum entanglement, in principle, could offer instantaneous flipping states (information) of records in multi-replicating registration protocols for the ledger replicas, eliminating enacting energy transmission [65,71].

#### 4. Conclusions

The energy sector and the source of electricity is evolving from analogue and fossil fuel dominated technologies to a new digital paradigm, based on energy from renewable sources, especially solar and wind. Beyond the environmental concern related to the current huge use of electricity for maintaining blockchain systems, there are numerous alternatives available that can decrease the impact, such as solar power and other renewable energy sources. While financial transactions have costs that are part of product or service price, vendors which utilize blockchain technology allow for near-zero transaction costs even on microtransactions. It enables the removal of intermediaries, such as banks, at both ends of the purchase, avoiding also cross-border fees.

Production, distribution, and the use of electricity affect modern industry, communications, and numerous services necessary for the global population. Seeing the importance and need for electricity in all spheres of modern human society there is a parallel



need to design regulatory that will fight against energy poverty, and it has to be central element of sustainable development of the energy market. It is necessary that business that uses blockchain is regulated to ensure transparency and fairness, as without clear regulations innovation will be set aside from the fear of being outside of the law. Without regulations blockchain technologies risk allowing fraudulent purveyors to use smart technologies. Regulations should define positive models of emission reduction of polluting gases with use of renewable energy sources on the global scale, with uniform portfolios that will enable a more secure energy future in terms of security of supply, competitiveness, and environmental sustainability. There is a need for regulations that will define the electricity market and ensure daily access to sustainable energy services, while integrating access to sustainable energy microgrid services, resulting in energy-efficient solutions.

Decades since blockchain appeared with Bitcoin, it is finding application within existing trading infrastructure not only for energy but eventually for all industries linked to that basic need for energy. However, the question of energy consumption associated with blockchain applications could become a future area for constraining regulatory attention. By considering the energy consumption architecture from first principles, the issue of addressing scalability has been illustrated. In this respect, the development of quantum information handling is already showing potential for advancing blockchain within a responsible environmental energy-controlled framework. These include future research avenues, such as the new perspective and vision of vehicle to grid (V2G) development and applications, as considered in [72], which should be examined in the light of this survey adopting a V2G energy transaction system based on the consortium blockchain. In addition, applying innovative approaches in turn suggest further application extensions on the basis of these research findings [72–74]. Examples of these include raw material sourcing, where the blockchain concept can be readily expanded for improved oversight and transparency—this latter being of prime importance if planetary resources are to be conserved.

Given the wide-reaching nature of this review, we offer here a breakdown of the references firstly into main focus groupings, and secondly providing further breakdown into the type of document content, as shown in Table 4.

**Table 4.** References adopted after search criteria broken down into focus and sub-types according to trade, algorithm, and review.

Publication Focus	Reference Numbers for each focus area	Publication content type		
		Based on Pilot Project or Trade Search Results	Algorithm Based on Available Data	Literature Review and Reports
History of blockchain	[1,2,10,11,13–16]	[11,14,16]	[13]	[1,10,15]
Blockchain networks type	[6,9,23,24,32,40,59]	[9,24,40]	[59]	[6,23,32]
Consensus mechanism in blockchain	[32–37,50]	[34–37]	[35]	[32]
Aspect of sustainable trade in the blockchain	[3,5–8,12,26,30,40,42,44,49–52,74]	[12,26,30,40,42,49]	[3,5,50,51]	[8,50,74]
Renewable energy and circular economy	[18–22,42,43,45,49]	[19,22,49]	[43]	[18,19,42]
Blockchain within renewable energy trade	[17,20,22,25,27,28,30,35,36,39,46,47,52–57,59]	[17,30,35,39,47,55]	[22,28,36,46,54,56]	[25,27,52,53,57,59]
Critical aspect of energy use in blockchain mining	[60–65,67,68,70]	[61,62,65,67]	[60,64,68,70]	[63,64]
Regulatory development niche for blockchain use	[2,4,6,31,72–74]	[4,31]	[2,6,72,73]	[74]

**Author Contributions:** E.B. contributed substantially to the interpretation of the relevant literature and to the writing of the manuscript. K.D.-M. drafted the article. M.I. critically revised the article for important intellectual content. V.S.B. contributed substantially to the conception and design of the article. P.G. designed and contributed graphics, and provided analysis from first principles of energy consumption. M.H. and P.G. supervised on the topic. All authors have read and agreed to the published version of the manuscript.

**Funding:** This research received no external funding.

**Data Availability Statement:** The data that support the findings of this study are available from the corresponding author upon reasonable request.

**Acknowledgments:** The work was partly supported by Omya International AG, Group Sustainability and MESTD Serbia, grant no. 451-03-68/2022-14/200105.

**Conflicts of Interest:** The authors declare no conflicts of interest.

## References

- Christidis, K.; Devetsikiotis, M. Blockchains and smart contracts for the internet of things. *IEEE Access* **2016**, *4*, 2292–2303.
- Peters, G.; Panayi, E.; Chapelle, A. Trends in crypto-currencies and blockchain technologies: A monetary theory and regulation perspective. *arXiv* **2015**, arXiv:1508.04364. <https://doi.org/10.48550/arXiv.1508.04364>
- Al Barghuthi, N.B.; Mohamed, H.J.; Said, H.E. Blockchain in supply chain trading. In Proceedings of the 2018 Fifth HCT Information Technology Trends (ITT), Dubai, United Arab Emirates, 28–29 November 2018; IEEE Press: New York, NY, USA, 2018; pp. 336–341.
- Kolb, J.; Abdel Baky, M.; Katz, R.H.; Culler, D.E. Core concepts, challenges, and future directions in blockchain: A centralized tutorial. *ACM Comput. Surv.* **2020**, *53*, 1–39.
- Hazard, J.; Slavounis, O.; Stieber, H. Are transaction costs drivers of financial institutions? Contracts made in Heaven, Hell, and the cloud in between. In *Banking Beyond Banks and Money*; Springer: Cham, Switzerland, 2016; pp. 213–237.
- Bano, S.; Al-Bassam, M.; Danezis, G. The road to scalable blockchain designs. *USENIX Login Mag.* **2017**, *42*, 31–36.
- Ganne, E. *Can Blockchain Revolutionize International Trade?*; World Trade Organization: Geneva, Switzerland, 2018; p. 152.
- Belu, M.G. Application of blockchain in international trade: An overview. *Rom. Econ. J.* **2019**, *77*, 2–16.
- Tapscott, D.; Iansiti, M.; Karim, R.L. *Insight You Need to Know from Blockchain*; Harvard Business Review Press: Boston, MA, USA, 2019; ISBN: 9781633698291.
- Salah, K.; Rehman, M.H.U.; Nizamuddin, N.; Al-Fuqaha, A. Blockchain for AI: Review and open research challenges. *IEEE Access* **2019**, *7*, 10127–10149.
- Aggarwal, S.; Kumar, N. History of blockchain—Blockchain 1.0: Currency. In *Advances in Computers*; Elsevier: Amsterdam, The Netherlands, 2021; pp. 147–169.
- Kizildag, M.; Dogru, T.; Zhang, T.C.; Mody, M.A.; Altin, M.; Ozturk, A.B.; Ozdemir, O. Blockchain: A paradigm shift in business practices. *Int. J. Contemp. Hosp. Manag.* **2019**, *32*, 953–975.
- Drew, J. Real talk about artificial intelligence and blockchain. *J. Account.* **2017**, *224*, 22.
- Ortega, V.; Bouchmal, F.; Monserrat, J.F. Trusted 5G vehicular networks: Blockchains and content-centric networking. *IEEE Veh. Technol. Mag.* **2018**, *13*, 121–127.
- CoinDesk. Crypto-Currency Market Capitalizations. 2017. Available online: <https://coinmarketcap.com> (accessed on 22 December 2022).
- Decker, C.; Seidel, J.; Wattenhofer, R. Bitcoin meets strong consistency. In Proceedings of the 17th International Conference on Distributed Computing and Networking, Singapore, 4–7<sup>th</sup> January 2016; pp. 1–10. <https://doi.org/10.1145/2833312.2833321>
- Sun, J.; Yan, J.; Zhang, K.Z. Blockchain-based sharing services: What blockchain technology can contribute to smart cities. *Financ. Innov.* **2016**, *2*, 26; <https://doi.org/10.1186/s40854-016-0040-y>
- Perišić, M.; Barceló, E.; Dimić-Mišić, K.; Imani, M.; Spasojević Brkić, V. The Role of Bioeconomy in the Future Energy Scenario: A State-of-the-Art Review. *Sustainability* **2022**, *560*, 436–454.
- Dimić-Mišić, K.; Barceló, E.; Spasojević-Brkić, V.; Gane, P.A.C. Identifying the challenges of implementing a European bioeconomy based on forest resources: Reality demands circularity. *FME Trans.* **2019**, *47*, 60–69.
- Gane, P.A.C.; Dimić-Mišić, K.; Barać, N.; Imani, M.; Janačković, D.; Uskoković, P.; Barceló, E. Unveiling a recycling-sourced mineral-biocellulose fibre composite for use in combustion-generated NO<sub>x</sub> mitigation forming plant nutrient: Meeting sustainability development goals in the circular economy. *J. Appl. Sci.* **2020**, *10*, 3927.
- Mould, K.; Silva, F.; Knott, S.F.; O’Regan, B. A comparative analysis of biogas and hydrogen, and the impact of the certificates and blockchain new paradigms. *Int. J. Hydrogen Energy* **2022**, *47*, 39303–30318.
- Masoudi, N.; Dahmardeh Ghaleho, N.; Esfandiari, M. Investigating the impacts of technological innovation and renewable energy on environmental pollution in countries selected by the International Renewable Energy Agency: A quantile regression a roach. *Casp. J. Environ. Sci.* **2020**, *18*, 97–107.

23. Maitra, S.; Yanambaka, V.P.; Puthal, D.; Abdelgawad, A.; Yelamarthi, K. Integration of Internet of Things and blockchain toward portability and low energy consumption. *Trans. Emerg. Telecommun. Technol.* **2021**, *32*, e4103.
24. Tariq, U.; Ibrahim, A.; Ahmad, T.; Bouteraa, Y.; Elmogy, A. Blockchain in internet-of-things: A necessity framework for security, reliability, transparency, immutability and liability. *IET Commun.* **2018**, *13*, 3187–3192.
25. Bachhav, A.; Kharat, V.; Shelar, M. Processing Distributed Internet of Things Data with Query Optimization in Cloud. *Int. J. Res. Anal. Rev.* **2018**, *6*, 122–124.
26. Kiesling, L. *Innovations and Decentralized Energy Markets: Technologies and Institutions for a Clean and Prosperous Energy Future*; Policy Paper; Center for Growth and Opportunity: Logan, UT, USA, 2020; Volume 3.
27. Nakamoto, S. Bitcoin: A peer-to-peer electronic cash system. *Decent. Bus. Rev.* **2008**, 21260. Available online: [https://www.meteora.co.jp/Satoshi\\_Nakamoto.pdf](https://www.meteora.co.jp/Satoshi_Nakamoto.pdf) (accessed on 22 December 2022).
28. Wu, J.T.; Tran, N.K. Application of blockchain technology in sustainable energy systems: An overview. *Sustainability* **2018**, *10*, 3067.
29. Esmat, A.; de Vos, M.; Ghiassi-Farrokhfal, Y.; Palensky, P.; Epema, D. A novel decentralized platform for peer-to-peer energy trading market with blockchain technology. *Appl. Energy* **2021**, *282*, 116123.
30. Park, L.W.; Lee, S.; Chang, H. A Sustainable Home Energy Prosumer-Chain Methodology with Energy Tags over the Blockchain. *Sustainability* **2018**, *10*, 658.
31. Hang, L.; Ullah, I.; Kim, D.H. A secure fish farm platform based on blockchain for agriculture data integrity. *Comput. Electron. Agric.* **2020**, *170*, 105251.
32. Fan, Z.; Kulkarni, P.; Gormus, S.; Efthymiou, C.; Kalogridis, G.; Sooriyabandara, M.; Chin, W.H. Smart grid communications: Overview of research challenges, solutions, and standardization activities. *IEEE Commun. Surv. Tutor.* **2012**, *15*, 21–38.
33. Gervais, A.; Karame, G.O.; Wüst, K.; Glykantzis, V.; Ritzdorf, H.; Capkun, S. On the security and performance of proof of work blockchains. In Proceedings of the 2016 ACM SIGSAC Conference on Computer and Communications Security, Vienna, Austria, 24–28 October 2016; pp. 830–842. <https://doi.org/10.1145/2976749.2978357>.
34. Pahlajani, S.; Kshirsagar, A.; Pachghare, V. Survey on private blockchain consensus algorithms. In Proceedings of the 2019 1st International Conference on Innovations in Information and Communication Technology (ICIICT), Chennai, India, 25–26 April 2019; IEEE Press: New York, NY, USA, 2019; pp. 1–6.
35. Lepore, C.; Ceria, M.; Visconti, A.; Rao, U.P.; Shah, K.A.; Zanolini, L. A survey on blockchain consensus with a performance comparison of PoW, PoS and pure PoS. *Mathematics* **2020**, *8*, 1782.
36. Mengelkamp, E.; Notheisen, B.; Beer, C.; Dauer, D.; Weinhardt, C. A blockchain-based smart grid: Towards sustainable local energy markets. *Comput. Sci. Res. Dev.* **2018**, *33*, 207–214.
37. Gramoli, V. From blockchain consensus back to Byzantine consensus. *Future Gener. Comput. Syst.* **2020**, *107*, 760–769.
38. Suyambu, G.T.; Anand, M.; Janakirani, M. Blockchain—A most disruptive technology on the spotlight of world engineering education paradigm. *Procedia Comput. Sci.* **2020**, *172*, 152–158.
39. Dorfleitner, G.; Muck, F.; Scheckenbach, I.; Blockchain applications for climate protection: A global empirical investigation. *Renew. Sustain. Energy Rev.* **2021**, *149*, 111378.
40. Yang, A.; Li, Y.; Liu, C.; Li, J.; Zhang, Y.; Wang, J. Research on logistics supply chain of iron and steel enterprises based on blockchain technology. *Future Gener. Comput. Syst.* **2019**, *101*, 635–645.
41. Jiang, T.; Song, J.; Yu, Y. The influencing factors of carbon trading companies applying blockchain technology: Evidence from eight carbon trading pilots in China. *Environ. Sci. Pollut. Res.* **2022**, *29*, 28624–28636.
42. Sotchenko, Y. Blockchain technology into steel industry current state of foreign payment activity. *Three Seas Econ. J.* **2021**, *2*, 78–84.
43. Yildizbasi, A. Blockchain and renewable energy: Integration challenges in circular economy era. *Renew. Energy* **2021**, *176*, 183–197.
44. Liu, J.; Lv, J.; Dinçer, H.; Yüksel, S.; Karakuş, H. Selection of renewable energy alternatives for green blockchain investments: A hybrid IT2-based fuzzy modelling. *Arch. Comput. Methods Eng.* **2021**, *28*, 3687–3701.
45. Wang, G. SoK: Understanding BFT Consensus in the Age of Blockchains. *Cryptol. Eprint Arch.* **2021**, 911. Available online: <https://ia.cr/2021/911> (accessed on 22 December 2022).
46. Alexandra, K. Corporate social responsibility through the example of Wanhua-Borsodchem Zrt. *Multidiscip. Stud.* **2021**, *11*, 386–401.
47. Ropuszynska-Surma, E.; Weglarz, M. The virtual power plant—A review of business models. In *E3S Web of Conferences*; EDP Sciences: Paris, France, 2019; Volume 108, p. 01006.
48. Naeem, M.A.; Karim, S.; Hasan, M.; Lucey, B.M.; Kang, S.H. Nexus between oil shocks and agriculture commodities: Evidence from time and frequency domain. *Energy Econ.* **2022**, *112*, 106148.
49. Lo, Y.C.; Medda, F. Assets on the blockchain: An empirical study of Tokenomics. *Inf. Econ. Policy* **2020**, *53*, 100881.
50. Wang, Q.; Li, R.; Wang, Q.; Chen, S. Non-fungible token (NFT): Overview, evaluation, opportunities and challenges. *arXiv* **2021**, arXiv:2105.07447. <https://doi.org/10.48550/arXiv.2105.07447>.
51. Lambert, T.; Liebau, D.; Roosenboom, P. Security token offerings. *Small Bus. Econ.* **2022**, *59*, 299–325.
52. Bongini, P.; Osborne, F.; Pedrazzoli, A.; Rossolini, M. A topic modelling analysis of white papers in security token offerings: Which topic matters for funding? *Technol. Forecast. Soc. Chang.* **2022**, *184*, 122005.

53. Svetec, E.; Nađ, L.; Pašičko, R.; Pavlin, B. Blockchain application in renewable energy microgrids: An overview of existing technology towards creating climate-resilient and energy independent communities. In Proceedings of the 16th International Conference on the European Energy Market (EEM), Ljubljana, Slovenia, 18–20 September 2019; IEEE Press: New York, NY, USA, 2019; pp. 1–7. <https://doi.org/10.1109/EEM.2019.8916292>.
54. Diestelmeier, L. Changing power: Shifting the role of electricity consumers with blockchain technology—Policy implications for EU electricity law. *Energy Policy* **2019**, *128*, 189–196.
55. Kounelis, I.; Giuliani, R.; Geneiatakis, D.; Di Gioia, R.; Karopoulos, G.; Steri, G.; Neisse, R.; Nai Fovino, I. *Blockchain in Energy Communities, A Proof of Concept*; EUR 29074 EN; Publications Office of the European Union: Luxembourg, 2017; ISBN 9789279777738. <https://doi.org/10.2760/121912>.
56. Saboori, H.; Mohammadi, M.; Taghe, R. Virtual power plant (VPP), definition, concept, components and types. In Proceedings of the 2011 Asia-Pacific Power and Energy Engineering Conference, Wuhan, China, 25–28 March 2011; pp. 1–4.
57. Brenna, M.; Falvo, M.C.; Foadelli, F.; Martirano, L.; Poli, D. From virtual power plant (VPP) to sustainable energy microsystem (SEM): An opportunity for buildings energy management. In Proceedings of the IEEE Industry Applications Society Annual Meeting, Addison, TX, USA, 18–22 October 2015; IEEE Press: New York, NY, USA, 2015; pp. 1–8.
58. Asumus, P. Microgrids, virtual power plants and our distributed energy future. *Electr. J.* **2010**, *23*, 72–82.
59. Buenrostro, E.D.; Rivera, A.O.G.; Tosh, D.; Acosta, J.C.; Njilla, L. Evaluating Usability of Permissioned Blockchain for Internet-of-Battlefield Things Security. In Proceedings of the MILCOM 2019—Military Communications Conference, Norfolk, VA, USA, 12–14 November 2019; IEEE Press: New York, NY, USA, 2019; pp. 841–846. <https://doi.org/10.1109/MILCOM47813.2019.9020736>.
60. Kumagai, J. Virtual power plants, real power. *IEEE Spectr.* **2012**, *49*, 13–14.
61. Bekenstein, J.D. Energy cost of information transfer. *Phys. Rev. Lett.* **1981**, *46*, 623.
62. Li, J.; Li, N.; Peng, J.; Cui, H.; Wu, Z. Energy consumption of cryptocurrency mining: A study of electricity consumption in mining cryptocurrencies. *Energy* **2019**, *168*, 160–168.
63. Bruno, A.; Weber, P.; Yates, A. *Can Bitcoin Mining Increase Renewable Electricity Capacity?*; CESifo Working Paper No. 9973; Center for Economic Studies and ifo Institute (CESifo): Munich, Germany, 2022; ISSN 23641428.
64. Ji, Q.; Bouri, E.; Roubaud, D.; Kristoufek, L. Information interdependence among energy, cryptocurrency and major commodity markets. *Energy Econ.* **2019**, *81*, 1042–1055.
65. Jogenfors, J. Quantum bitcoin: An anonymous, distributed, and secure currency secured by the no-cloning theorem of quantum mechanics. In Proceedings of the IEEE International Conference on Blockchain and Cryptocurrency (ICBC), Seoul, Republic of Korea, 14–17 May 2019; IEEE Press: New York, NY, USA, 2019; pp. 245–252.
66. Jiang, W. Energy to Transmit One Bit. 10 November 2018: submitted as coursework for PH240, Stanford University, Fall 2018. Available online: <http://large.stanford.edu/courses/2018/ph240/jiang1/> (accessed on 22 December 2022).
67. Feng, W.; Li, Y.; Yang, X.; Yan, Z.; Chen, L. Blockchain-based data transmission control for Tactical Data Link. *Digit. Commun. Netw.* **2021**, *7*, 285–294.
68. Energyguide.Be. Available online: <https://www.energuide.be/en/questions-answers/how-much-power-does-a-computer-use-and-how-much-co2-does-that-represent/54/> (accessed on 22 December 2022).
69. Kohli, V.; Chakravarty, S.; Chamola, V.; Sangwan, K.S.; Zeadally, S. An Analysis of Energy Consumption and Carbon Footprints of Cryptocurrencies and Possible Solutions. *arXiv* **2022**, arXiv:2203.03717.
70. Parthasarathy, A.; Krishnamachari, B. DEFER: Distributed Edge Inference for Deep Neural Networks. In Proceedings of the 14th International Conference on Communication Systems & Networks (COMSNETS), Bangalore, India, 4–8 January 2022; IEEE Press: New York, NY, USA, 2022; pp. 749–753.
71. Bennet, A.J.; Shakib, D. Energy efficient mining on a quantum-enabled blockchain using light. *Ledger* **2019**, *4*, 82–107. <https://doi.org/10.5195/ledger.2019.143>.
72. Ismail, A.-A.; Mbungu, N.T.; Elnady, A.; Bansal, R.C.; Hamid, A.-K.; Al-Shabi, M. (in-press) Impact of electric vehicles on smart grid and future predictions: A survey. *Int. J. Model. Simul.* **2022**, 1–15. <https://doi.org/10.1080/02286203.2022.2148180>.
73. Hamid, A.-K.; Mbungu, N.T.; Elnady, A.; Bansal, R.C.; Ismail, A.-A.; Al-Shabi, M.A. A systematic review of grid-connected photovoltaic and photovoltaic/thermal systems: Benefits, challenges and mitigation. *Energy Environ.* **2022**, *0*. <https://doi.org/10.1177/0958305X221117617>.
74. Koottappillil, D.P.; Naidoo, R.M.; Mbungu, N.T.; Bansal, R.C. Distribution of renewable energy through the energy internet: A routing algorithm for energy routers. *Energy Rep.* **2022**, *8*, 355–363. <https://doi.org/10.1016/j.egy.2022.10.201>.

**Disclaimer/Publisher’s Note:** The statements, opinions and data contained in all publications are solely those of the individual author(s) and contributor(s) and not of MDPI and/or the editor(s). MDPI and/or the editor(s) disclaim responsibility for any injury to people or property resulting from any ideas, methods, instructions or products referred to in the content.