

# Numerical study of wind actions applied to a low profile container crane

**Luigi Solazzi**

Assistant Professor  
University of Brescia  
Department of Mechanical and Industrial  
Engineering  
Italy

**Nenad Zrnić**

Associate Professor  
University of Belgrade  
Faculty of Mechanical Engineering

*The target of this numerical study is to investigate the problems involved in the design of a low profile container crane exposed both to static and dynamic wind actions, in order to establish if these loads are dangerous when compared with the load induced by standard container load and unload operations.*

*In the first step the work was performed by means of different schematizations of the wind load action allowed by the standards; the second step regarded the application of a real trend (velocity of wind versus time) obtained experimentally on a similar crane positioned in an Italian harbor.*

*The results obtained in terms of maximum displacement depend on the crane load conditions and on the different schematizations used for the wind action. Using a variable wind pressure, the research shows that the effects of wind loads are greatly influenced by the natural vibration frequencies of both the structure and the elements that compose the structure.*

**Keywords:** wind actions, low profile container crane, lattice structure, finite element analysis.

## 1. INTRODUCTION

Generally speaking, wind actions are not the main load conditions considered in the design of structures in the civil or mechanical engineering sectors. However, in recent years continuous researches for increase the material performance have generated exponential progresses in the development and use of slender, flexible and lightweight structures, to the point where the structures' vulnerability to wind action and correlated phenomena must not be underestimated [1].

For example, [2] and [3] report some studies on cranes collapsed due to wind action. Obviously, in addition to wind action, these structures are also subjected to the force induced by load. This action, which also depends on the type of driving unit, should be carefully considered together with the action of the wind because they may act simultaneously [4], [5], [6].

Due to the fact that cranes and other lifting devices are big and flexible structures, they cannot be designed without considering wind actions.

The low profile container crane considered in this study is illustrated in Figure 1. The state of the art in this sector has adopted a precise classification which allocates load lifting unit and transporting equipment into clearly defined categories based on its logistical role and function: this crane is in category A2 (low-profile container crane), and therefore it is equipped with a boom which moves horizontally within the gantry structures.

In order to evaluate the stress on the crane caused by the wind, many finite element analyses (FEM) were also carried out to calculate the peak displacement in the boom. This variable is very important because the spreader connection mechanisms are remote controlled, and therefore even slight displacement reduces the precision of the mechanism and increases unloading times: this phenomenon increases the total cost of unloading-loading operations. Wind action is therefore important and fundamental for calculating both the safety coefficients of the structure and to quantify the boom displacement as a direct correlation to the increase in container loading-unloading time.

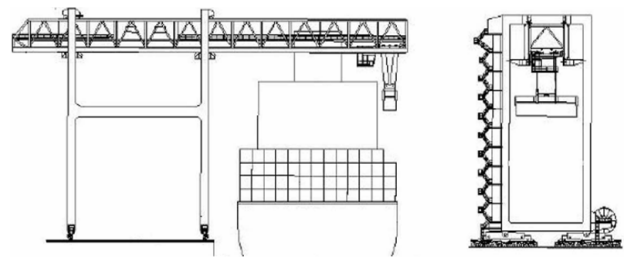

**Figure 1. Low profile container crane, working load limit = 50 t, boom length = 80 m, waterside = 38 m, overall height 55 m.**

## 2. WIND ACTIONS

The wind actions, forces and moments acting on the whole structure, or on its individual elements, are correlated to the size of the structure, to the maximum pressure (generally strictly dependent on the wind velocity) and to a number of dynamic and shape coefficients. In general, the larger the exposed surface is, the greater the relative action on the structure is.

Received: April 2015, Accepted: June 2015

Correspondence to: Dr Luigi Solazzi  
University of Brescia, Department of Mechanical  
and Industrial Engineering, Via Branze 25 128 Brescia,  
Italy, E-mail: luigi.solazzi@unibs.it

doi:10.5937/fmet1601029S

© Faculty of Mechanical Engineering, Belgrade. All rights reserved

It is important to underline that in the wind engineering field, the stress and the displacement in the structures due to the wind actions are directly proportional to the flexibility of the structure or element (related to the natural frequencies of the construction). For instance, the maximum value of displacement is correlated to the intrinsic damping of the material used and to the different methodologies used to join the elements together, such as welding or bolting [7-12].

Moreover, vortex streets are generated in case of downwind of the constructions and their elements, causing dynamic forces, mainly transversally to the direction of the wind.

These vortex streets may become particularly important for slender, lightweight structures with low damping capacity, subjected to alternate vortex shedding that may excite some vibration modes of the structure [13-16].

However, many constructions and their elements are rigid enough with a high damping coefficient, which limits the dynamic effects caused by aero-elastic phenomena.

In these cases, wind actions can be represented by means of equivalent load distributions which, statically applied to the construction or its elements, provide maximum values for the displacement and stress generated by the dynamic wind action. Therefore in this case it is possible to use the equivalent static actions, which, as stated above, incorporate both static and dynamic actions [17], [18].

### 3. DEFINITION OF THE PROBLEM

The crane design process, developed in previous studies, was carried out in accordance with the specific standards (EN 13000, etc.). The conventional component design and verification procedures defined by the standards have been implemented through many analyses in order to calculate the effects of seismic actions on the structure, and specifically their incidence and significance in relation to the actions generated by standard operations of the crane [19], [20].

Other studies concern the use of composite materials in lifting equipment in order to reduce their weight and thus modify their frequencies and therefore the relative dynamic actions [21].

Another important aspect was the assessment of environment conditions, and especially corrosion (these structures are generally installed in harbors and subjected to salt-water spray), which affects the behavior of joints, especially bolted joints [22].

With this background, the research studies the wind action using several different models for estimating the load of the wind on the structure.

For this study it is assumed that the low profile container crane is installed in Liguria (Italy) and, in accordance with the 2008 Italian Construction Technical Standards, a design wind velocity of 28 m/s, acting in various directions, is considered for the analysis of the equivalent static action.

The wind action was evaluated by [23-26].

Geometrical analyses show that the direction across the boom is the most dangerous, both because the surface area exposed to the wind is largest and because

the force applied to the boom submits the gantry to twisting and so the displacement at the end of the boom is the highest in this case.

The first step for an effective analysis of the problem is the definition of the different load conditions for a low profile container crane.

Figure 2 shows the crane studied under the two different geometrical configurations: a) waterside; b) landside.

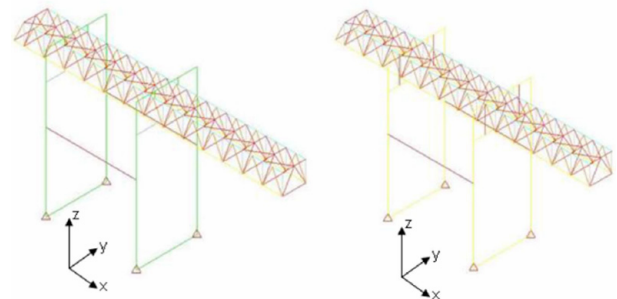

Figure 2. Different geometrical configurations of the crane

#### a. Load conditions

The load conditions analyzed are the following; obviously they do not cover all the crane's possible use configurations, but they are chosen as the most representative conditions.

- A. Crane with boom at the landside position without container.
- B. Crane with the boom at the waterside position with container.
- C. Crane with boom at the waterside position with container. This condition corresponds to loading / unloading the container on the ship.
- D. Crane with boom at the landside position with container. This condition corresponds to loading / unloading the container from the quay.

The low profile container crane is modelled using quadratic beam elements; these elements have been chosen because the crane is realized using slender elements (for example standard profiles): one dimension is significantly greater than the other two, therefore the slender beam assumption is justified. In order to have a greater precision the chosen elements have a quadratic formulation (Figure 3).

Under operating conditions with a container, its weight generates a vertical action, which is taken into account by applying four concentrated weights on the boom end nodes, and a horizontal action due to the wind.

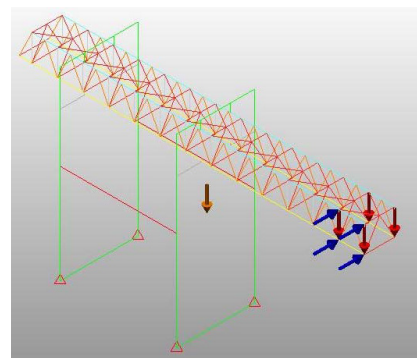

Figure 3. Load action due the container on the crane

The wind action generated on the crane can be calculated using the following equations [6]:

$$F_Y = q_p(z) \cdot L^2 \cdot c_{FY} \quad (1)$$

$$q_p(z) = \frac{1}{2} \cdot \rho \cdot v_r^2 \cdot c_e(z) \quad (2)$$

$$c_{FY} = c_{FY0} \cdot \psi_\lambda \quad (3)$$

$$\psi_\lambda = A + B \cdot \phi \quad (4)$$

where the force acting on the structure is proportional to the pressure range, characteristic dimension and force coefficient. Since the standard [23] does not specify structures with geometry similar to those of the crane, the design engineer must choose the better schematization for defining the force coefficient.

### b. Schematization

As follows it is showed the plausible schematizations for the structure adopted in this study, and they are different for the gantry (P,Q,R and S) and the boom (1,2,3,4 and 5).

Decisive factor for quantifying wind forces is the factor  $c_{FY}$  that depends essentially on the geometry, the ratio between area and full area of the elements and the distance between the elements themselves.

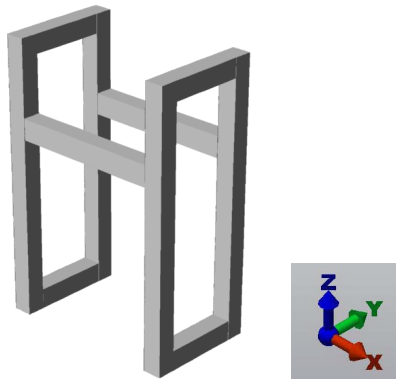

Figure 4. Gantry schematization

**P-Q:** The gantry is considered to be the sum of two flat, parallel lattice beams placed one downwind from the other (a distance between the two, perpendicular to the wind, of about 15 m). The difference between Hypothesis P and Hypothesis Q is that in the first case the beams are supposed to be far enough apart to prevent the generation of masking effects between them. In the second case, it is assumed that the downwind beam is subjected to a lower wind action due to the masking effect of the upwind beam.

$$c_{FY}P = 1.7, c_{FY}Q = 0.26 \quad (5)$$

**R:** The gantry is considered as a lattice structure (Figure 5).

$$c_{FY}R = 3 \quad (6)$$

**S:** Each element of the gantry (vertical and horizontal) is studied individually.

$$c_{FY}S = 2.1 \quad (7)$$

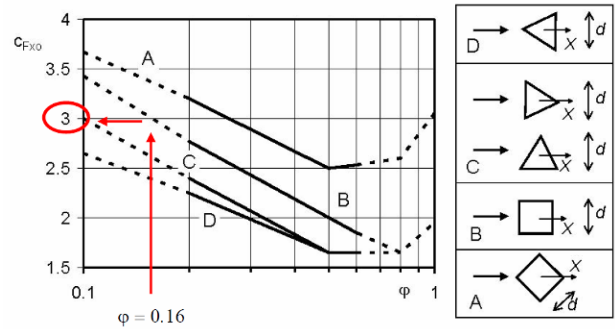

Figure 5.

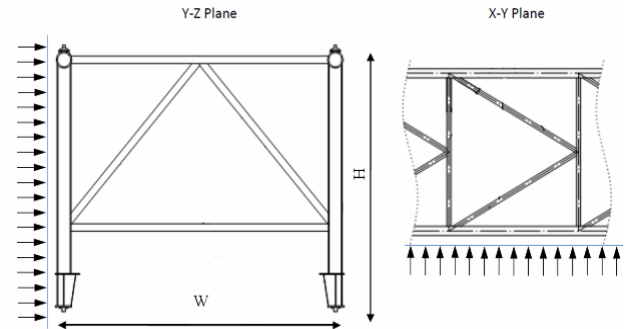

Figure 6. Design of the boom (H = 6 m, W = 7 m)

**1-2:** As in Hypothesis P, the boom is considered to be the sum of two flat, parallel lattice beams placed one downwind from the other (with a distance between them, perpendicular to the wind, of about 7 m). The difference between Hypothesis 1 and Hypothesis 2 is the estimation of the surface area directly exposed to the wind.

The total area exposed to the wind can increase if even the stiffening and bracing elements are considered.

$$c_{FY}1 = 1.6 \quad (8)$$

**3-4:** The boom is considered as a lattice structure. Here again, as in Hypotheses 1 and 2, different area densities, leading to different wind forces, are obtained depending on which elements are considered.

$$c_{FY}3 = 2.25 \quad (9)$$

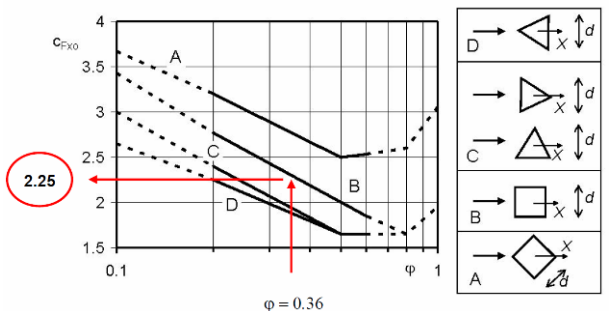

Figure 7.

**5:** Each element that makes up the boom is considered separately.

$$c_{FY}5 = 2.38 \quad (10)$$

Table 1 contains the results of the peak wind force for different schematization of both the gantry and the boom. The table 2 is the same, but considers the contribution of a container, which has a significant surface area exposed to the wind.

**Table 1. Different values of peak wind force for crane without container \*10<sup>6</sup> [N]**

Gantry /Boom	1	2	3	4	5
P	1,831	1,983	1,942	2,052	2,219
Q	1,333	1,485	1,444	1,554	1,722
R	2,729	2,881	2,840	2,950	3,118
S	2,107	2,259	2,218	2,328	2,496

**Table 2. Different values of peak wind force for crane with container \*10<sup>6</sup> [N]**

Gantry /Boom	1	2	3	4	5
P	1,883	2,035	1,994	2,104	2,272
Q	1,386	1,538	1,497	1,606	1,774
R	2,782	2,934	2,893	3,003	3,170
S	2,160	2,312	2,271	2,380	2,548

A comparison between the values of the forces acting on the structure, as shown in the tables above, clearly reveals that the wind action for different schematizations adopted is highly variable; therefore, a large number of analyses were performed to assess the wind action on the crane, considering various load conditions derived from the forces defined in Tables 1 and 2 for each load conditions (A, B, C and D).

In order to be clear, only the results for the models considering the maximum and minimum wind force on the structure are shown.

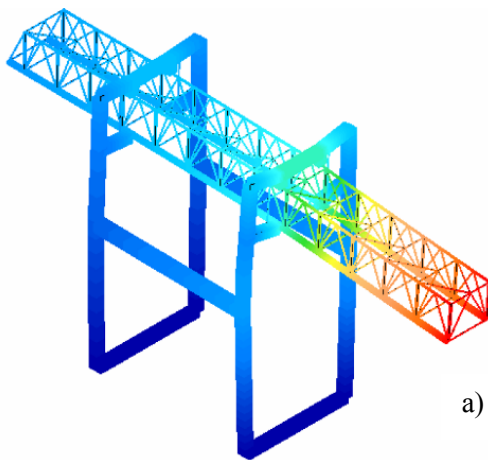

a)

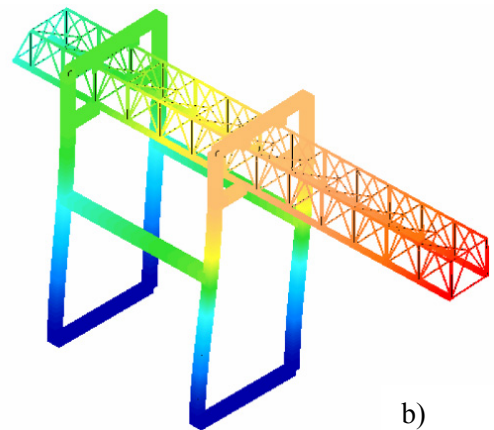

b)

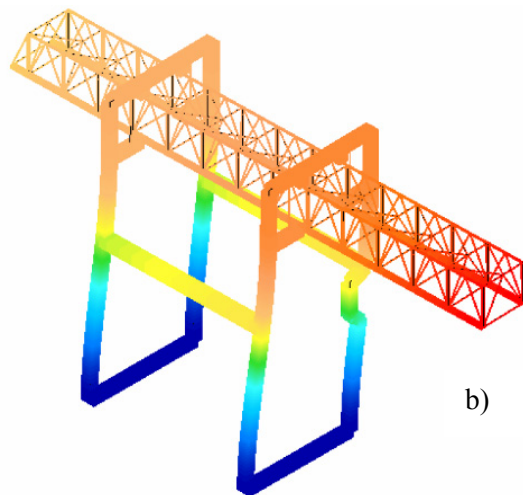

b)

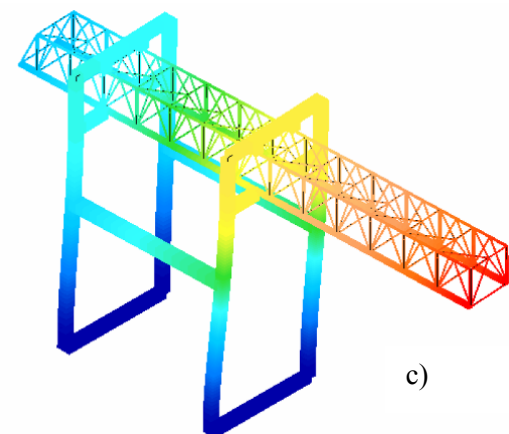

c)

**Figure 9. Displacement in the crane in load condition C, for static load a), F Max b) and min c)**

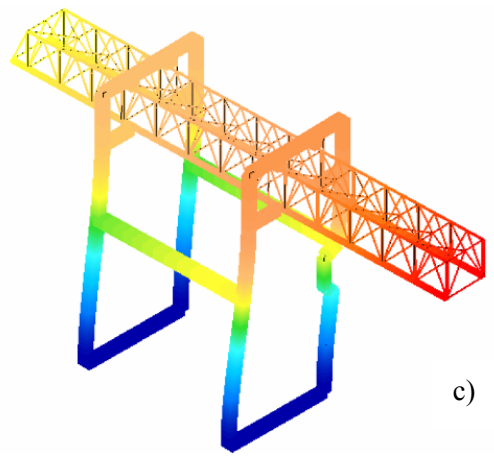

c)

**Figure 8. Displacement in the crane in load condition A, for static load a), F Max b) and min c)**



**Table 3. Maximum displacement for crane in load condition A in correspondence of static action, maximum and minimum force [mm]**

Load condition A	Magnitude	X	Y	Z
Static	71.5	13.6	9.9	-70.3
F_Max	2381.6	110.1	2379.4	-95.8
F_Min	1175.1	72.1	1172.1	-81.3

**Table 4. Maximum displacement for crane in load condition B in correspondence of static action, maximum and minimum force [mm]**

Load condition B	Magnitude	X	Y	Z
Static	125.8	25.4	20.1	-123.3
F_Max	2646.4	190.9	2640.2	-166.1
F_Min	1368.3	129.5	1359.8	-143.7

**Table 5. Maximum displacement for crane in load condition C in correspondence of static action, maximum and minimum force [mm]**

Load condition C	Magnitude	X	Y	Z
Static	287.0	62.2	34.1	-280.2
F_Max	2924.6	264.0	2904.2	-330.4
F_Min	1654.7	202.6	1623.8	-308.0

**Table 6. Maximum displacement for crane in load condition D in correspondence of static action, maximum and minimum force [mm]**

Load condition D	Magnitude	X	Y	Z
Static	97.7	12.9	18.4	-96.8
F_Max	2586.7	161.7	2582.3	-139.6
F_Min	1307.7	100.3	1302.3	-117.3

#### 4. DISCUSSION

Generally speaking, regardless of the configuration of the crane, the wind action generates a value of displacement much higher than the one obtained by the numerical analysis in the loading condition in which it acts only the weight of the crane and the weight of the container.

The maximum displacement in correspondence of the maximum action, is about 2.5 m (in transversal direction with respect to the axis of the boom), making connection to and disconnection from the container virtually impossible. In general, for all load conditions, the transversal displacement in respect to the vertical displacement, due to the load of container is about fifteen time in the schematization with maximum force and is about ten time in the schematization with minimum force.

The stress in the crane at maximum wind force is about three times compared to the one calculated in the absence of the wind. For the correct interpretation of the results, it must be highlighted that under the static condition, the load (container and weight of the crane itself) acts in a vertical direction (z), while the action of the wind is horizontal (y).

#### 5. DYNAMIC EFFECT

Once the equivalent static schematization of the wind action on the crane had been completed, the next step was to analyze the vortex shedding, which can cause resonance in the structure.

In the literature, there are several researches correlated to the probabilistic phenomena of the wind action [27] or related to the dynamical action induced by the wind [28]. In all these researches, it is fundamental to evaluate both Strouhal number and the Scruton number [29], but due to the lack of detailed data it was not possible to establish these parameters with an acceptable reliability.

Therefore, the only possible procedure was to subject the crane to time-varying load, in order to establish whether the wind and the structure could potentially resonate. Given the availability of the wind velocity measurements for the whole month of April 2012 (Figure 9) on the similar crane, in the harbor of La Spezia (Italy), it was possible to realize a curve (velocity of the wind - time), which was then scaled to periods of 8, 4 and 2 seconds, to highlight the gust effect. These periods were chosen because they are fully compatible both with the micro-meteorological peaks in the Van der Hoven graph and with the resonance periods of the crane under consideration, as established through a preliminary modal analysis of the crane [6].

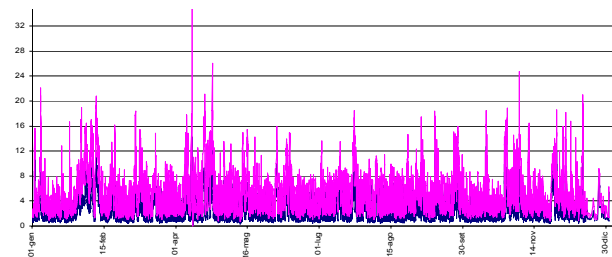

**Figure 10. Average and maximum wind velocity [m/s] during April 2012**

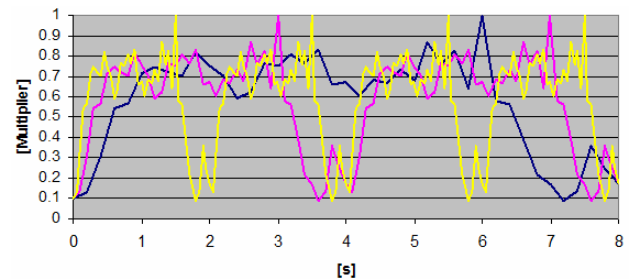

**Figure 11. Time-variant stress created (blue = 8 s; purple = 4 s; yellow = 2 s)**

After plotting the three time-variable curves and applying the actions to the structure for each type of configuration, the graphs of the maximum displacement in relation to time were extracted, for point indicated in figure 12. The figures 13-14 and 15 concern the load conditions C. When the trend in the results for the three chosen periods are compared, it is possible to say that when the load frequency is increased, the displacement trend is amplified, a clear sign of interaction between the wind and the structure. In summary, it is clear that the size of the second and third peak in comparison to the first varies depending on the oscillation period.

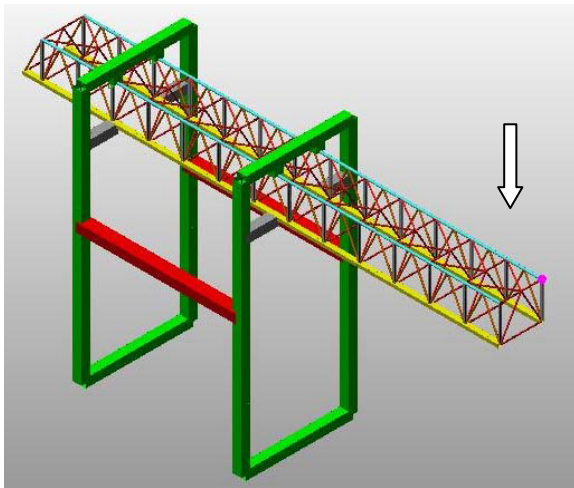

Figure 12. Point adopted to evaluate the displacement in the crane

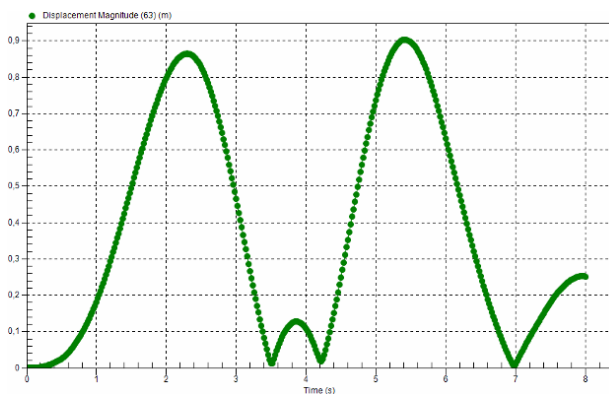

Figure 13. Displacement in load condition C –  $F_{max}$  Model - 8 s Period [m]

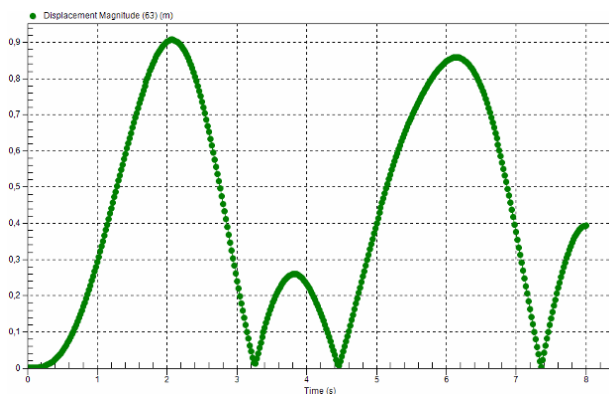

Figure 14. Displacement in load condition C –  $F_{max}$  Model - 4 s Period [m]

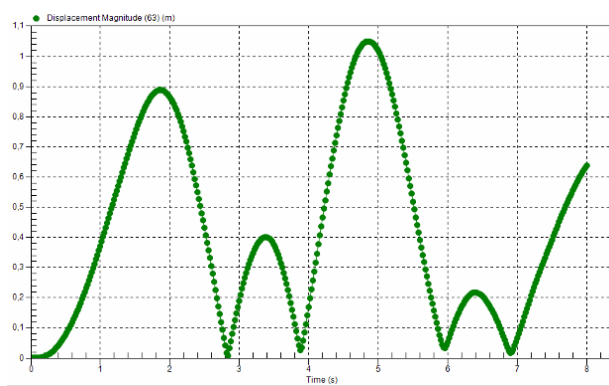

Figure 15. Displacement in load condition C –  $F_{max}$  Model - 2 s Period [m]

## 6. CONCLUSION

The subject of this study is a low profile container crane, subjected to the wind action in the transversal direction of the boom, at a velocity of 28 m/s (force 10 on the Beaufort scale). With the model adopted for the wind action, i.e. the method suggested by the NTC 2008 and Eurocode standards [23], [24] for the calculation by means of the equivalent static force, the results for displacement and Von Mises equivalent stress are highly variable. In particular, with a very rough approximation of the model under the unfavorable wind action, there is a very large increase in displacement and consequently in the stress compared to the wind-free condition. Similar results are obtained for all the load conditions analysed.

It is particularly important that the study performed simulating a wind pressure variation in time. In this case, using experimental data obtained on similar crane from the harbor of La Spezia, it has been found that the crane is extremely sensitive to time depending actions because the first natural frequencies of the crane are comparable to those of the wind action, leading to an amplification both for the displacement and for the stress.

## ACKNOWLEDGMENTS

The author wishes to thank to mechanical engineers Morabito Andrea and Cima Michele for their support in this research.

## REFERENCES

- [1] Karting, G., Grösel, B. and Zrnić, N.: Past, state-of-art and future of intralogistics in relation to megatrends, FME Transactions, Vol 40, pp.193-200, 2012.
- [2] McCarthy, P., Soderberg, E. and Dix, A.; *Wind damage to dockside cranes: recent failures and recommendations*, in TCLEE 2009, 28-06/02-07.2009, Oakland, California.
- [3] Dong, H.K., Byung, C.O., Sang, H. H., Jae, S.S., In, S.C., Man, S.S. and Ji, S.J.; *Callpase of container cranes at busan ports under typhoon maemi*, in *Proceedings of the 14<sup>th</sup> international offshore and polar engineering conference*, 23-28.05.2004, Toulon, France, ISBN 1-880653-62-1, ISSN 1098-6189.
- [4] Gašić, V. and Zrnić, N.: Considerations of various moving load models in structural dynamics of large gantry cranes, FME Transactions, Vol 41, pp. 311-316, 2013.
- [5] Zrnić, N., Gašić, V., Bošnjak, S. and Ćorović, M.: Moving loads in structural dynamics of crane: bridging the gap between theoretical and practical research, FME Transactions, Vol 41, pp.291-297, 2013.
- [6] Solazzi, L., Incerti, G. and Petrogalli, C.: *Estimation of the dynamic effect in the lifting operations of a boom crane*, in ECMS 2014, 27-30.05.2004, Brescia, pp.309-315.
- [7] Prandtl, L. and Tietjens, O.G.: *Applied Hydro- and Aeromechanics*, Dover Publications, New York, 1984.

- [8] Simiu, E. and Scanlan, R.H.: *Wind effects on structures: Fundamentals and applications to design*, 3<sup>rd</sup> Edition, John Wiley & Sons, New York, 1996.
- [9] Cook, N.J.: *The designer's, guide to wind loading of buildings structures. Part 1: Background, damage survey, wind data and structural classification*, Butterworths, London 1985.
- [10] Cook, N.J.: *The designer's guide to wind loading of buildings structures. Part 2: Static structures*, Butterworths, London 1985.
- [11] Scruton, C.: *An Introduction to Wind Effects on Structures*, Oxford University Press, 1981.
- [12] Sachs, P.: *Wind forces in engineering*, Pergamon Press, 1978.
- [13] Augusti, G., Materazzi, A. L. and Sepe, V.: *Ingegneria del vento, introduzione alla progettazione strutturale alla luce della nuova normativa*, International Centre of Mechanical Sciences (2001).
- [14] Dyrbye, C. and Ole Hansen, S.: *Wind Loads on Structures*, Wiley, New York 1997.
- [15] Davenport, A.G., Riera, J.D., *Wind effects on building and structures*, Taylor & Francis, 1998.
- [16] Tamura Y., Karrem A., *Advances structural wind engineering*, Springer, 2013.
- [17] Blaise, N., Canor, T. and Denoel, V.: Equivalent static wind loads for structures with non proportional damping, in *Rasd 2013 11<sup>th</sup> International conference on Recent and Advances in Structural Dynamics* 01-03.07.2013, Pisa (Italy), Paper 828.
- [18] Sang-Joon, L. and Jong-Hoon, K.: Wind load on a container crane located in atmospheric boundary layers, *J. of Wind Engineering and Industrial Aerodynamics*, Vol. 96, pp. 193-208, 2008.
- [19] Solazzi, L.: Ship to shore crane subject to earthquake, in: *11th International Conference on the Mechanical Behaviour of Materials*, June 5-9/2011 Milano, Italy.
- [20] Solazzi, L.: Dynamical behaviour of cranes subjected to different types of earthquake, in: *XX International conference on "Material Handling, Constructions and Logistics"*, Belgrade, Serbia, 3-5 October 2012.
- [21] Solazzi, L. and Scalmana, R.: New Design Concept for a Lifting Platform made of Composite Material, *Applied Composite Materials, An International Journal for Science and Application of Composite Materials*, Published online: 14 September 2012.
- [22] Solazzi, L., Scalmana, R., Gelfi, M. and La Vecchia, G.M.: Effect of Different Corrosion Levels on the Mechanical Behaviour and Failure on Threaded elements, *Journal of Failure Analysis and Prevention* 2012, DOI:10.1007/s11668-012-9593-x, Published online: 04 August 2012
- [23] Ministero dei lavori Pubblici: *Norme tecniche relative ai "Carichi generali per la verifica di sicurezza delle costruzioni e dei carichi e sovraccarichi" e relative "Istruzioni"*, Gazzetta Ufficiale della Repubblica Italiana, n.29 (supplemento) e n. 217 (supplemento), 1996.
- [24] European Committee for Standardisation, *Eurocode 1: Basis of design and actions on Structures*, Brussels, ENV 1991-2-1, 1995.
- [25] Cook, N.J.: *The designer's Guide to Wind Loading of Building Structures, Part 1. Building Research Establishment (BRE)*, Butterworths, 1995.
- [26] *Wind effects on building and design of wind sensitive structures*, CISM International centre for mechanical sciences, Springer 2007.
- [27] Scarabino, A., Mara $\square$ on Di Leo, J., Delnero, J.S., Bacchi, F.: Drag coefficients and strouhal numbers of a port crane boom girder section, *J. of Wind Engineering and Industrial Aerodynamics*, Vol. 93, pp. 451-460, 2005.
- [28] Sourav, G. and Samit, R.: Probabilistic assessment of container crane under wind loading, in: *Proceedings of the International Symposium on engineering under uncertainty: safety assessment and management (ISEUSAM 2012)*, DOI 10.1007/978-81-322-0757-3\_72, Springer India 2013.
- [29] Bošnjak, S., Zrnić, N. and Dragović, B.: Dynamic response of mobile elevating work platform under wind excitation, *J. of Mechanical Engineering*, Vol. 55, pp.104-113, 2009.

---

## НУМЕРИЧКА АНАЛИЗА ДЕЈСТВА ВЕТРА НА НИСКО ПРОФИЛНЕ КОНТЕЈНЕРСКЕ ДИЗАЛИЦЕ

**Луиђи Солаци, Ненад Зрнић**

Циљ представљене нумеричке анализе је да истражи проблеме који су обухваћени у поступку пројектовања ниско профилних контејнерских дизалица изложених статичком и динамичком дејству ветра, како би се утврдило да ли су ова оптерећења опасна ако се упореде са стандардним радним оптерећењем које се јавља у току претовара контејнера.

У првом кораку истраживање је спроведено помоћу различитих шема дејства ветра које су дате у стандардима; У другом кораку је анализирано стварно стање (експериментално добијена брзина ветра у односу на време) и резултати су добијени за конкретну контејнерску дизалицу лоцирану у једној италијанској луци.

Добијени резултати у погледу максималних померања на структури зависе од оптерећења дизалице и примене различитих шема које се користе да би се обухватио утицај ветра. Коришћењем променљивог притиска ветра, истраживање показује да су ефекти оптерећења ветром у великој мери под утицајем сопствених фреквенција како носеће структуре, тако и елемената који чине структуру.